



# LCD TV 22

LS22A13W

## Owner's Instructions

Before operating the unit,  
please read this manual thoroughly,  
and retain it for future reference.

**ON-SCREEN MENUS  
TELETEXT  
PICTURE IN PICTURE**

## For Better Display

- 1 Adjust computer resolution and screen injection rate (refresh rate) in control panel of computer as described below to enjoy the best quality of picture. You can have an uneven quality of picture in the screen if the best quality of picture is not provided in TFT-LCD.
  - ◆ **Resolution** : 1280 x 720
  - ◆ **Vertical frequency** (refresh rate) : 60 Hz
- 2 TFT LCD panel manufactured by using advanced semiconductor technology with precision of 99.999% above is used for this product. But the pixels of RED, GREEN, BLUE and WHITE color seem to be bright sometimes or some of black pixels could be seen. This is not from bad quality and you can use it without uneasiness.
  - ◆ The number of TFT-LCD pixels that is contained in this product are 2,764,800.
- 3 When you clean the monitor and the panel outside, please apply the recommended small amount of cleaner by using soft and dry cloth and polish it. Let LCD area not to be forced but to be scrubbed out softly. If excessive force is applied, you can have a stain on it.

**Information in this document is subject to change without notice.**

**© 2002 Samsung Electronics Co., Ltd. All rights reserved.**

Reproduction in any manner whatsoever without the written permission of Samsung Electronics Co., Ltd. is strictly forbidden.

Samsung Electronics Co., Ltd. shall not be liable for errors contained herein or for incidental or consequential damages in connection with the furnishing, performance, or use of this material.

The **Samsung logo** is the registered trademarks of Samsung Electronics Co., Ltd.; **VESA**, **DPMS** and **DDC** are registered trademarks of Video Electronics Standard Association; the **ENERGY STAR** name and logo are registered trademarks of the U.S. Environmental Protection Agency (EPA). As an ENERGY STAR Partner, Samsung Electronics Co., Ltd. has determined that this product meets the **ENERGY STAR** guidelines for energy efficiency. All other product names mentioned herein may be the trademarks or registered trademarks of their respective owners.

## Safety Instructions

These illustrations represent precautions concerning your TV.

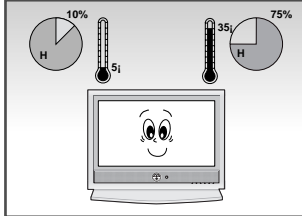

Do NOT expose the TV to extreme temperature conditions (below 5°C and above 35°C) or to extreme humidity conditions (less than 10% and more than 75%).

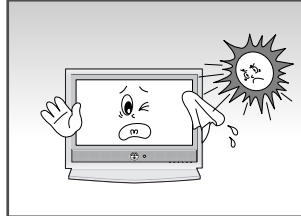

Do NOT expose the TV to direct sunlight.

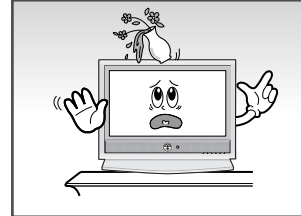

Do NOT expose the TV to any liquids.

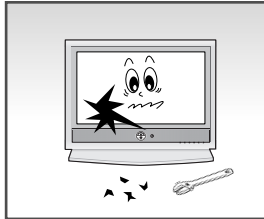

If the TV is broken, do not try to repair it yourself. Contact qualified service personnel.

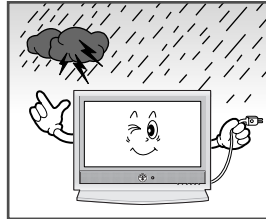

During a storm conditions (especially when there is lightning) unplug the TV from the mains socket and aerial.

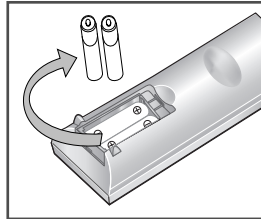

If the remote control is not used for a long period of time, remove the batteries and store it in a cool, dry place.

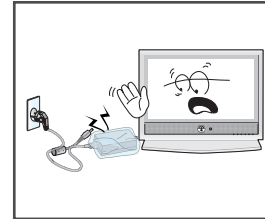

Remove and discard vinyl bag from power adaptor before use. Possible fire hazard.

**THIS DEVICE IS NOT FOR USE IN INDUSTRIAL ENVIRONMENTS**

## Caution

**CAUTION**  
RISK OF ELECTRIC SHOCK  
DO NOT OPEN

**CAUTION:** TO PREVENT ELECTRICAL SHOCK, DO NOT REMOVE REAR COVER, NO USER SERVICEABLE PARTS INSIDE. REFER SERVICING TO QUALIFIED SERVICE PERSONNEL.

The main voltage is indicated on the rear of the TV set and the frequency is 50 or 60Hz.

The lightning flash and arrow head within the triangle is a warning sign alerting you of "dangerous voltage" inside the product.



The exclamation point within the triangle is a warning sign alerting you of important instructions accompanying the product.



**WARNING:** TO PREVENT DAMAGE WHICH MAY RESULT IN FIRE OR SHOCK HAZARD. DO NOT EXPOSE THIS APPLIANCE TO RAIN OR MOISTURE.

Mode	System
CW/WS	PAL-B/G, D/K, I, SECAM-B/G,D/K, I, L/L', NTSC4.43
CS	PAL-B/G, D/K, I, SECAM-B/G,D/K, I, NTSC4.43/3.58

*Thank you for buying a SAMSUNG TV.*

*Please take the time to read these instructions, as they will help you to operate your TV with ease.*

## Contents

◆ FOREWORD	
■ Safety Instructions .....	3
■ Caution .....	3
◆ CONNECTING AND PREPARING YOUR TELEVISION	
■ Control Panels .....	6
■ Connection Panel .....	7
■ Infrared Remote Control .....	8
■ Connecting to an Aerial or Cable Television Network .....	9
■ Connecting a non-AV-Link VCR .....	9
■ Connecting a Satellite Receiver.....	10
■ Connecting a Decoder.....	10
■ Connecting to an Audio System and Sub-woofer .....	11
■ Inserting the Batteries in the Remote Control.....	11
■ Switching Your Television On and Off .....	12
■ Placing Your Television in Standby Mode .....	12
■ Becoming Familiar with the Remote Control .....	13
■ Plug and Play Feature .....	14
■ Choosing Your Language .....	15
◆ SETTING THE CHANNELS	
■ Automatic Storing of Channels .....	16
■ Sorting the Stored Channels.....	17
■ Manual Storing of Channels .....	18
■ Assigning Names to Channels.....	20
■ Skipping Unwanted Channels.....	21
■ Fine Tuning Channels.....	22
■ Adjusting the Picture Standard .....	23
■ Adjusting the Picture Settings.....	23
■ Selecting the Picture Format .....	24
■ Freezing the Picture.....	24
◆ SETTING THE SOUND	
■ Adjusting the Volume .....	25
■ Switching the Sound Off Temporarily .....	25
■ Selecting the Sound Standard .....	26
■ Selecting the Sound Settings.....	26
■ Selecting the Sound Mode.....	27
■ Selecting the Melody Sound .....	27
■ Virtual Dolby .....	28
■ Adjusting the Volume Automatically .....	28
■ Connecting the Headphones .....	29
■ Adjusting Your Headphone Preferences .....	29
■ Selecting the Sound.....	30

# Contents

◆	SETTING THE PICTURE	
■	Picture In Picture Feature .....	30
■	Selecting the Blue Screen Mode .....	32
◆	SETTING THE TIME	
■	Setting the Sleep Timer .....	32
■	Setting and Displaying the Current Time .....	33
■	Switching the Television On and Off Automatically .....	34
◆	SETTING THE PC	
■	Connecting to the PC Input.....	35
■	Adjusting the Screen Quality .....	36
■	Changing the Screen Position .....	36
■	Changing the Screen Colour Standard.....	37
■	Adjusting the Screen Colour Settings .....	37
◆	USING THE TELETEXT FEATURE	
■	Teletext Decoder .....	38
■	Displaying the Teletext Information .....	38
■	Selecting a Specific Teletext Page .....	39
■	Using FLOF to Select a Teletext Page .....	40
■	Storing Teletext Pages .....	40
◆	INFORMATION ON CONNECTIONS AND RECOMMENDATIONS FOR USE	
■	Connecting to the Component Input/Outputs .....	41
■	Connecting to the RCA Input .....	41
■	Connecting to the S-Video Input .....	42
■	Viewing Pictures From External Sources .....	43
■	Troubleshooting: Before Contacting Service Personnel .....	44
■	Display Modes .....	46
■	Attaching a wall or Arm mounting device.....	47
■	Installing VESA compliant mounting device .....	48
■	Kensington Slot.....	49
■	Specifications.....	50
■	Pin Assignments .....	51

## Symbols



Press



Push



Hold down



Important



Note

## Control Panels

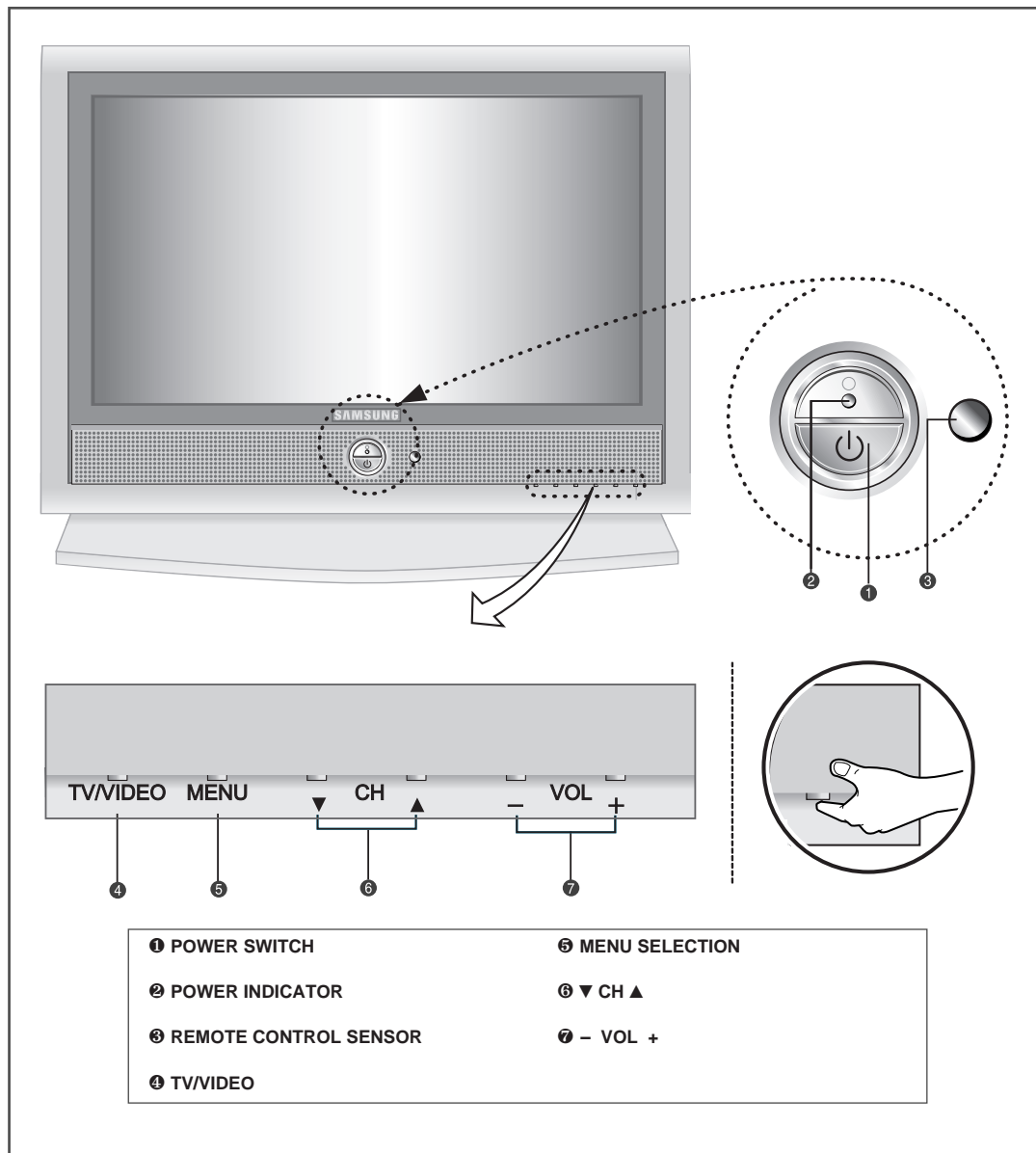

### ➤ *Using the Buttons on the Panel*

If the remote control no longer works or you have lost it, you can use controls on the panel of the TV to:

- ◆ Switch on the TV when it is in Standby mode and select channels ( ▼ CH ▲ )
- ◆ Access the local menu ( **MENU** )
- ◆ Adjust the volume ( - VOL + )
- ◆ Switch among Video input modes ( **TV/VIDEO** )

# Connection Panels

## Rear of TV

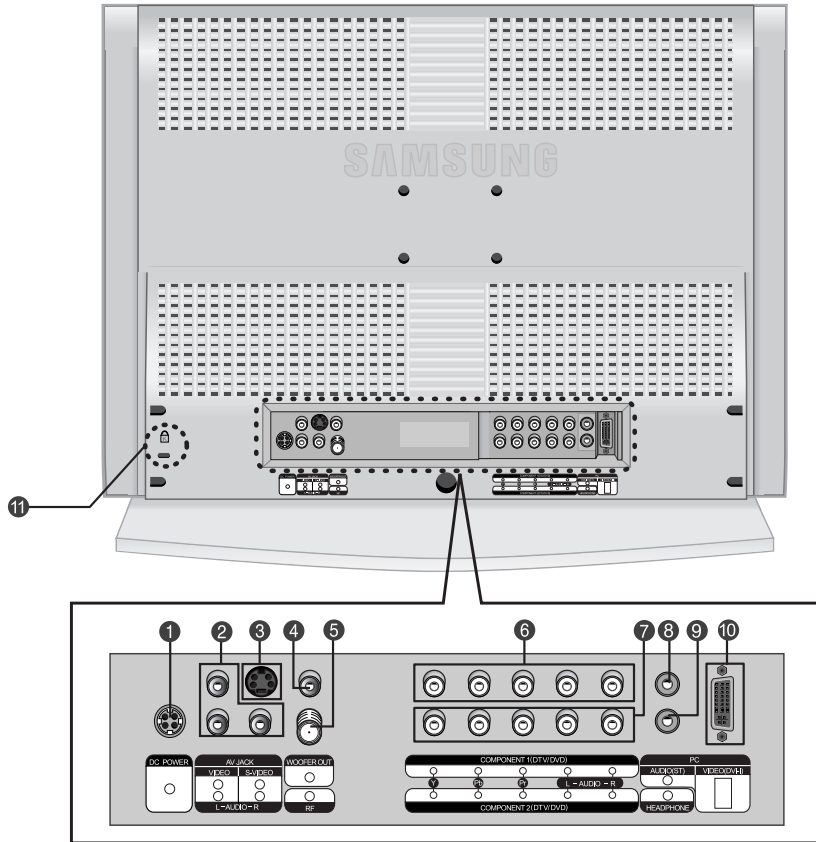

- ❶ POWER INPUT CONNECTOR
- ❷ RCA AUDIO/VIDEO INPUT CONNECTORS
- ❸ S-VIDEO INPUT CONNECTOR
- ❹ WOOFER OUTPUTS
- ❺ ANTENNA INPUT CONNECTOR
- ❻ COMPONENT 1 (DTV/DVD)
- ❼ COMPONENT 2 (DTV/DVD)
- ❽ PC AUDIO INPUT CONNECTOR
- ❾ HEADPHONE CONNECTOR
- ❿ PC VIDEO INPUT CONNECTOR
- ⓫ KENSINGTON LOCK (SEE PAGE 49)

# Infrared Remote Control

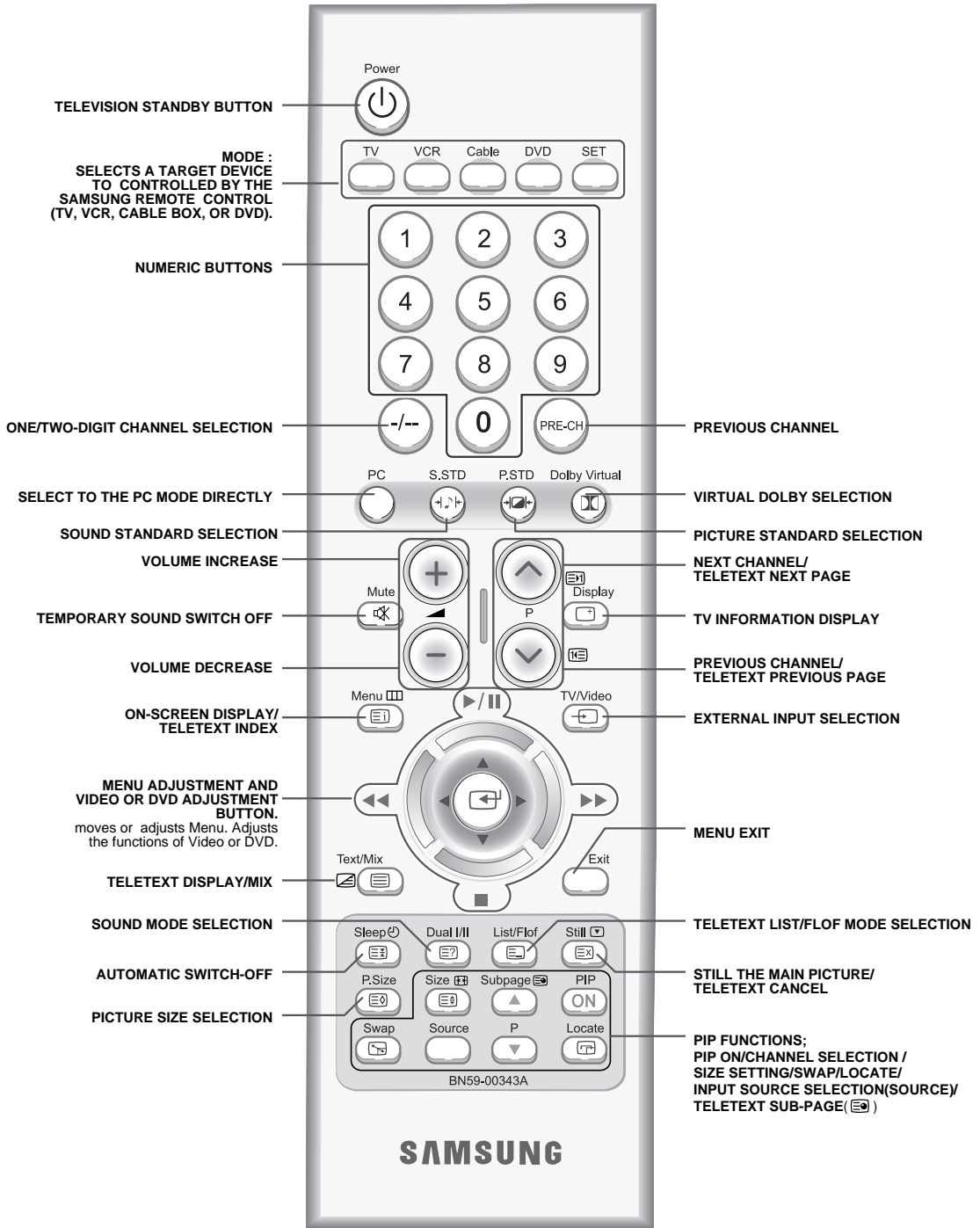

➤ It is possible that the work of the transmitter is dull or not operated normally if the light of the Bulb is on around the TV set.



## Connecting Connecting to an Aerial or Cable Television

To view TV channels correctly, a signal must be received by the set from one of the following sources:

- ◆ An outdoor aerial
- ◆ A cable TV network
- ◆ A satellite network (see page 10 for further details)

1 In the first three cases, connect the aerial or network input cable to the 75Ω coaxial socket on the rear of the TV.

2 If you are using an indoor aerial, you may need to turn it when tuning your TV until you obtain a picture that is both sharp and clear.

For further details, refer to:

- ◆ "Automatic Storing of Channels" on page 16
- ◆ "Manual Storing of Channels" on page 18

➤ If you wish to subscribe to a cable network, contact your local dealer.

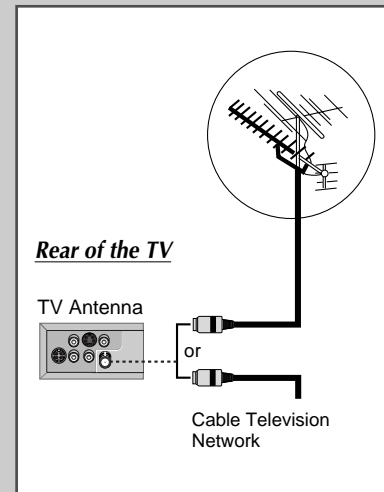

## Connecting a non-AV-Link VCR

You can connect a VCR to the TV using a:

- ◆ Coaxial cable
- ◆ S-Video cable

1 Plug the aerial input cable into the appropriate socket on the VCR.

2 Connect a coaxial cable to the:

- ◆ VCR aerial output socket
- ◆ Television aerial input socket

3 Follow the instructions supplied with your VCR to tune the VCR to your TV.

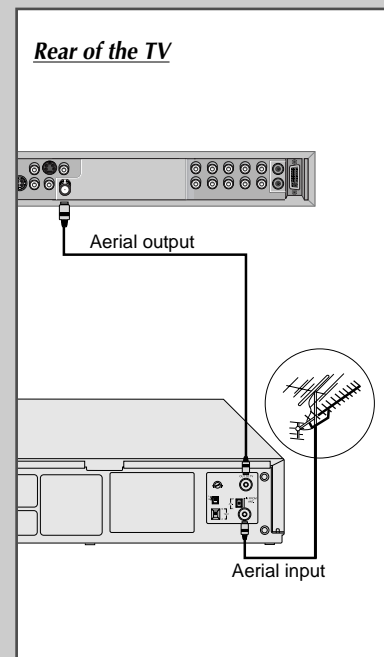

## Connecting a Satellite Receiver

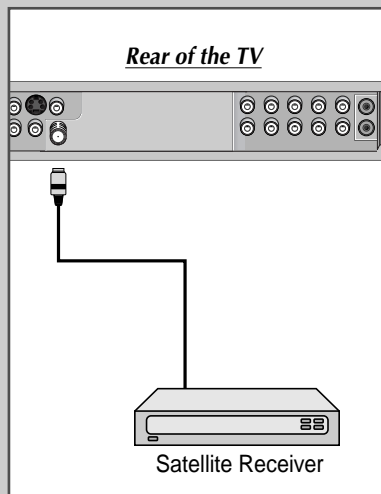

***In order to watch TV programmes broadcast via a satellite network, you must connect a satellite receiver to the TV set.***

- If you wish to connect both a satellite receiver and a VCR, you should connect the:
- ◆ Receiver to the VCR
  - ◆ VCR to the TV  
(see pages 41~42 for further details)
- Otherwise, connect the receiver directly to the TV.

### ***Using a coaxial cable***

Connect a coaxial cable to the:

- ◆ Receiver output socket.
- ◆ Television aerial input socket.

## Connecting a Decoder

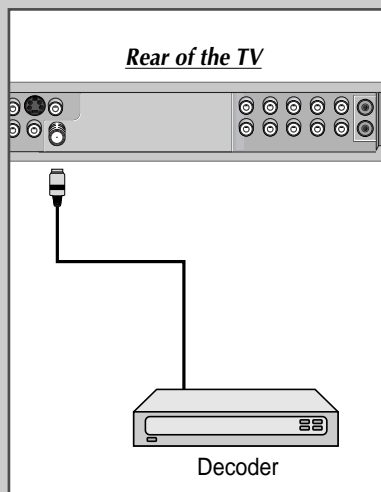

***In order to descramble a coded transmission signal, you must connect a decoder to the TV set.***

- If you wish to connect both a decoder and a VCR, you should connect the:
- ◆ Decoder to the VCR
  - ◆ VCR to the TV  
(see pages 41~42 for further details)
- Otherwise, connect the decoder directly to the TV.

### ***Using a coaxial cable***

Connect a coaxial cable to the:

- ◆ Receiver output socket.
- ◆ Television aerial input socket.

## Connecting to an Audio System and Sub-woofer

Connect a set of audio cables between the AUX L, R jacks on the AUDIO SYSTEM and the AUDIO OUTPUT L, R jacks on the TV.

Connect an audio cable between the INPUT jack on an active(powered) Sub woofer and the WOOFER OUT jack on the TV.

- ◆ The audio system and subwoofer are sold separately.

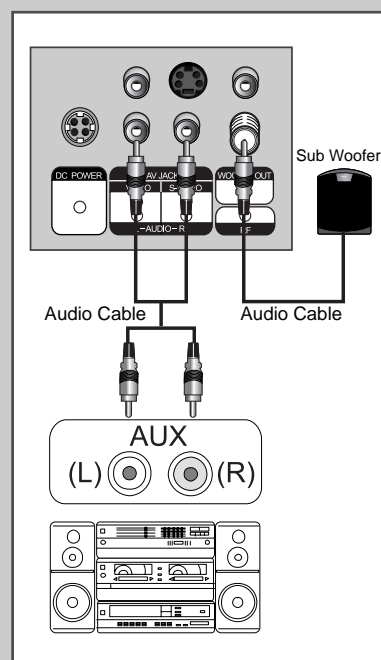

## Inserting the Batteries in the Remote Control

You must insert or replace the batteries in the remote control when you:

- ◆ Purchase the TV
- ◆ Find that the remote control is no longer operating correctly

- 1 Remove the cover on the rear of the remote control by pressing the symbol downwards and then pulling firmly to remove it.
- 2 Insert two R03, UM4, "AA" 1.5V or equivalent batteries taking care to respect the polarities:
  - ◆ + on the battery against + on the remote control
  - ◆ - on the battery against - on the remote control
- 3 Replace the cover by aligning it with the base of the remote control and pressing it back into place.

➤ Do not mix battery types, i.e. alkaline and manganese.

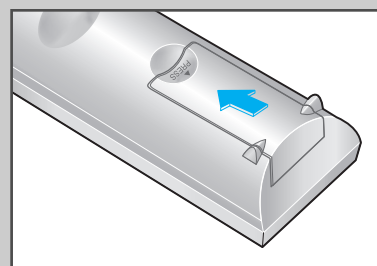
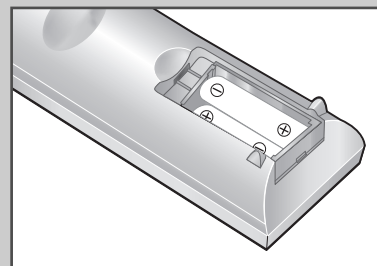
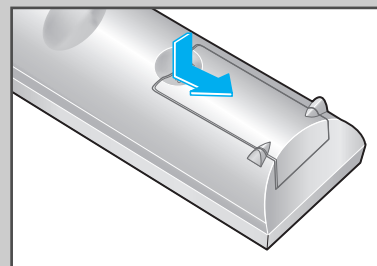

## Switching Your TV On and Off

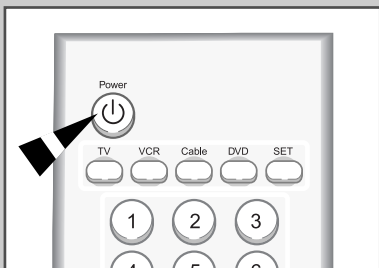
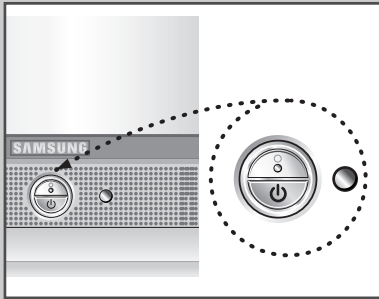

*The mains lead is attached to the rear of your TV.*

- 1 Plug the mains lead into an appropriate socket.  
Result: A green Standby indicator appears on the front of your television.

---

- 2 Press the **POWER** button (⏻).  
Result: The screen is turned on and a green Standby indicator disappears on the front of your television.  
(When the timer operates and the power is turned off, LED turns red.)

---

- 3 To switch your television off, press the **POWER** button (⏻) again.

## Placing Your Television in Standby Mode

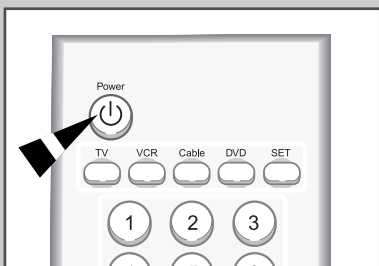
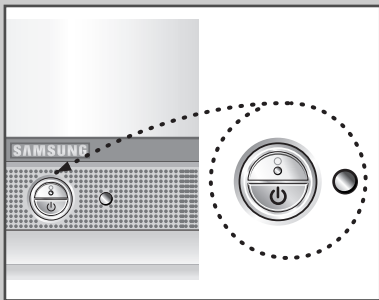

*Your television can be placed in Standby mode, in order to reduce the power consumption.*

*The Standby mode can be useful when you wish to interrupt viewing temporarily (during a meal, for example).*

- 1 Press the **POWER** button (⏻).  
Result: The screen is turned off and a green Standby indicator appears on the front of your television.

---

- 2 To switch your television back on, simply press the **POWER** button (⏻) button again.

➤ Do not leave your TV in Standby mode for long periods of time (when you are away on holiday, for example). Turn your television off by pressing the **POWER** button (⏻). It is best to unplug your television from the mains and aerial.

## Becoming Familiar with the Remote Control

The remote control is used mainly to:

- ◆ Change channels and adjust the volume
- ◆ Set up the TV using the on-screen menu system

The following table presents the most frequently used buttons and their functions.

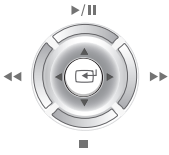
Button	Viewing Function	Menu Function
P^	Used to display the next stored channel.	
P^	Used to display the previous stored channel.	
	➤ For double digit channels, the second digit must be pushed immediately after the first. Failure to do this will result in a single digit channel being displayed.	
-	Used to reduce the volume.	
+	Used to increase the volume.	
		Used to: <ul style="list-style-type: none"> <li>◆ Display a submenu containing selections for the current menu option</li> <li>◆ Search forwards/backwards manually for channels</li> <li>◆ Increase/reduce a menu option value</li> </ul>
<b>MENU</b>	Used to display the on-screen menu system.	Used to return to the previous menu or normal viewing.
0 to 9	Used to display the corresponding channels.	Used to display the corresponding channel directly.

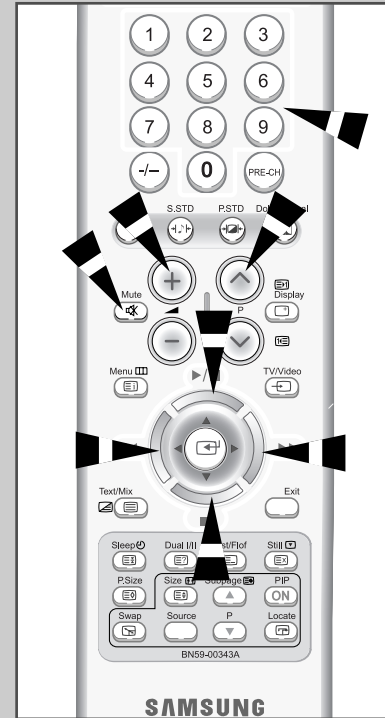

## Plug and Play Feature

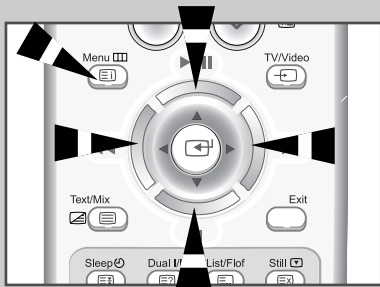

Plug & Play

Ant. Input Check

↔ Select [Menu] Exit

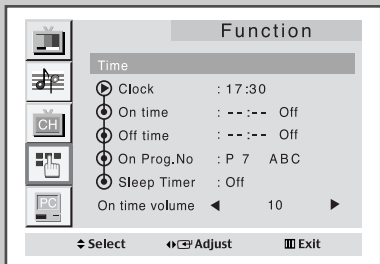
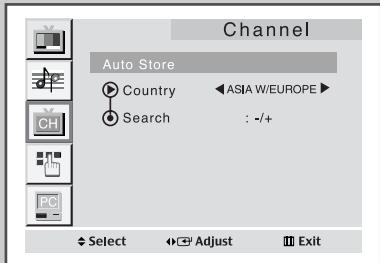

Enjoy Your Watching.

English-14

*When the TV is initially powered ON, two basic customer settings proceed automatically and subsequently. The following settings are available.*

- 1 If the TV is in Standby mode, press the **POWER** button (⏻) on the remote control.

Result: The message **Plug & Play** is displayed. It flickers for a little while, and then the **Language** menu is automatically displayed.

- 2 Select the appropriate language by pressing the **UP/DOWN ▲▼** button. Press the **MENU** button to enter the language.

Result: The message **Ant. Input : Check** is displayed.

- 3 Make sure that the antenna is connected to the TV. Press the the **LEFT/RIGHT ◀▶** button.

Result: The **Auto store** menu is displayed with **Area** is selected.

- 4 Select your area by pressing the **LEFT/RIGHT ◀▶** button. To search the channels, select **Search** by pressing the **UP/DOWN ▲▼** button, and then press the **LEFT/RIGHT ◀▶** button. Press the **MENU** button to stop the search.

Result: The **Time** menu is displayed with **clock** is selected. (Refer to "Automatic Storing of Channels" on page 16)

- 5 Press the the **LEFT/RIGHT ◀▶** to move to the hour or minute. Set the hour minute by pressing the **UP/DOWN ▲▼** button. (Refer to "Setting and Displaying the Current Time " on page 33)

- 6 When you have finished, press the **MENU** button.

Result: The message **Enjoy Your Watching** is displayed, and then the channel which has been stored will be activated.

## Plug and Play Feature

*If you want to reset this feature...*

- 1 Press the **MENU** button.  
Result: The main menu is displayed.
- 2 Press the **UP/DOWN ▲▼** button to select the **Function**.  
Press the **LEFT/RIGHT ◀▶** button.  
Result: The options available in the **Function** group are displayed.
- 3 Press the **UP/DOWN ▲▼** button to select the **Plug & Play**.
- 4 Press the **LEFT/RIGHT ◀▶** button.  
Result: The message **Plug & Play** is displayed.
- 5 For further details on how to set, refer to the opposite page 14.

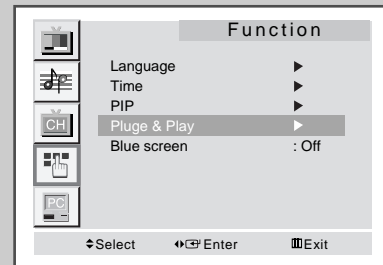

## Choosing Your Language

*When you start using your TV for the first time, you must select the language which will be used for displaying menus and indications.*

- 1 Press the **MENU** button.  
Result: The main menu is displayed.
- 2 Press the **UP/DOWN ▲▼** button to select the **Function**.  
Press the **LEFT/RIGHT ◀▶** button.  
Result: The options available in the **Function** group are displayed. The **Language** is selected.
- 3 Press the **LEFT/RIGHT ◀▶** button again.  
Result: The languages available are listed.
- 4 Press the **UP/DOWN ▲▼** button to select appropriate language.
- 5 When you are satisfied with your choice, press the **MENU** button to return to normal viewing.

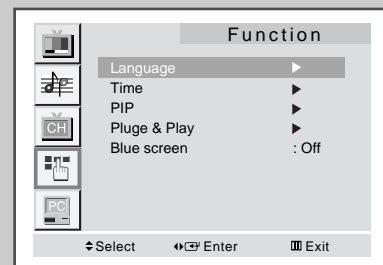
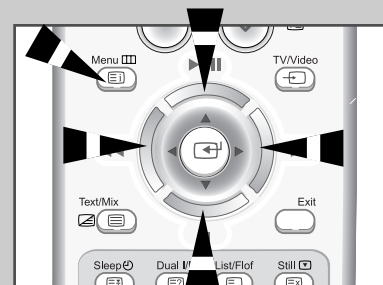

## Automatic Storing of Channels

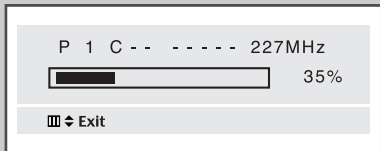
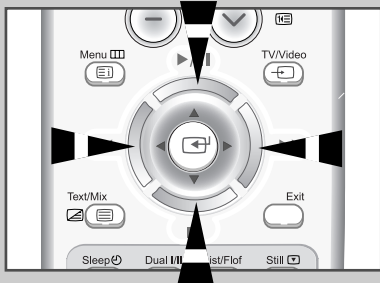
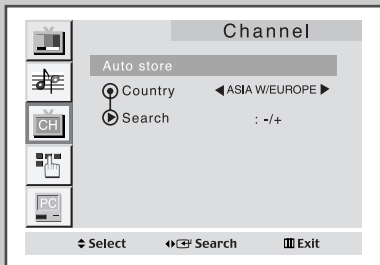
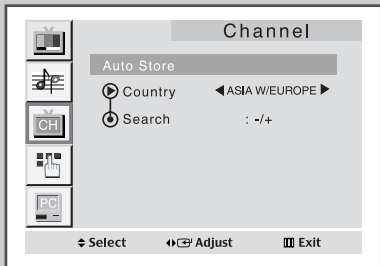
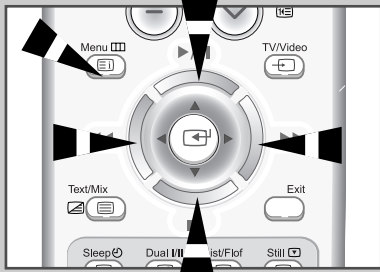

*You can scan for the frequency ranges available to you, (availability depends on your country). Automatically allocated programme numbers may not correspond to actual or desired programme numbers. However you can sort numbers manually and clear any channels you do not wish to watch (see pages 17~19 for further details).*

- 1 Press the **MENU** button.

Result: The main menu is displayed.

- 2 Press the **UP/DOWN ▲▼** button to select the **Channel**. Press the **LEFT/RIGHT ◀▶** button.

Result: The options available in the **Channel** group are displayed.

- 3 Press the **UP/DOWN ▲▼** button to select the **Auto store**. Press the **LEFT/RIGHT ◀▶** button.

Result: The options available in the **Auto store** group are displayed.

- 4 Press the **UP/DOWN ▲▼** button to select the **Country**.

- 5 Press the **LEFT/RIGHT ◀▶** to select your country. If you have selected the Others option but do not wish to scan the PAL frequency range, store the channels manually (see page 18).

- 6 Press the **UP/DOWN ▲▼** button to select the **Search**. Press the **LEFT/RIGHT ◀▶** button.

Result: The search will end automatically. Channels are sorted and stored in an order which reflects their position in the frequency range, (with lowest first and highest last). The programme originally selected is then displayed.

➤ To stop the search before it has finished, press the **MENU** button and **UP/DOWN ▲▼**.

- 7 When the channels have been stored, you can:
  - ◆ Sort them in the order required (see page 17)
  - ◆ Fine-tune channel reception if necessary (see page 22)
  - ◆ Assign a name to the stored channels (see page 20)



## Sorting the Stored Channels

*The Sort operation allows you to change the programme numbers of stored channels. This operation may be necessary after using ATM. You can delete those channels you do not want to keep.*

- 1 Press the **MENU** button.

Result: The main menu is displayed.

- 2 Press the **UP/DOWN ▲▼** button to select the **Channel**.  
Press the **LEFT/RIGHT ◀▶** button.

Result: The options available in the **Channel** group are displayed.

- 3 Press the **UP/DOWN ▲▼** button to select the **Sort**.  
Press the **LEFT/RIGHT ◀▶** button.

Result: The **Sort** menu is displayed.

- 4 Press the **UP/DOWN ▲▼** to select the **From**.

- 5 Press the **LEFT/RIGHT ◀▶** to select the channel that you wish.

- 6 Press the **UP/DOWN ▲▼** button to select the **To**.

- 7 Press the **LEFT/RIGHT ◀▶** to select the number of the programme to which the channel is to be moved.

- 8 Press the **UP/DOWN ▲▼** button to select the **Store**.

- 9 Press the **LEFT/RIGHT ◀▶** button to select the **OK**.

Result: The channel is moved to its new position.

- 10 Repeat Steps 6 to 11 until you have moved all the channels to the required programme numbers.

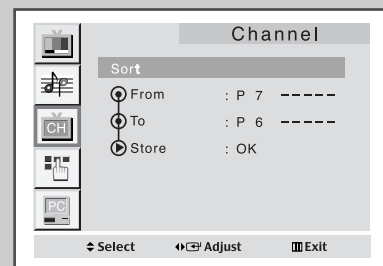
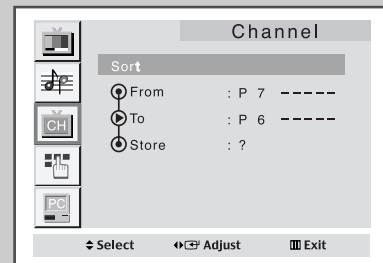
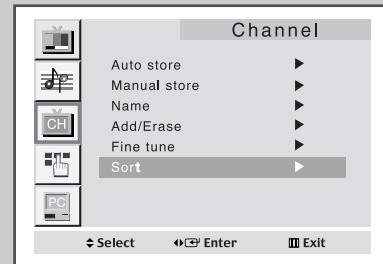
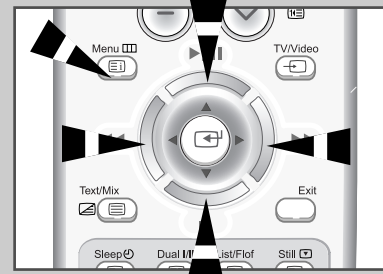

## Manual Storing of Channels

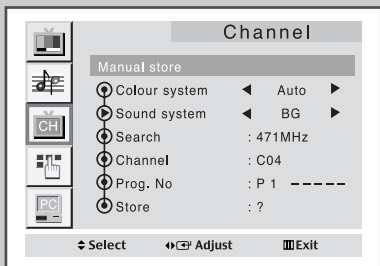
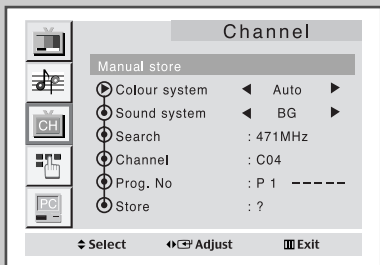
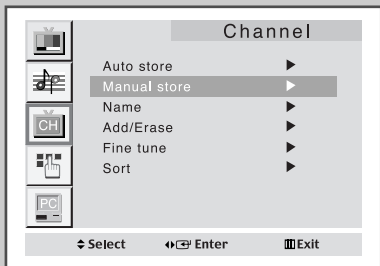
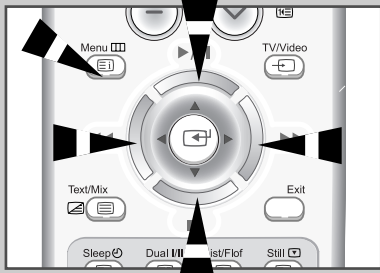

You can store up to 100 TV channels, including those received via cable networks.

When storing channels manually, you can choose:

- ◆ Whether or not to store each of the channels found
- ◆ The programme number by which you wish to identify each stored channel

1 Press the **MENU** button.

**Result:** The main menu is displayed.

2 Press the **UP/DOWN ▲▼** button to select the **Channel1**.  
Press the **LEFT/RIGHT ◀▶** button.

**Result:** The options available in the **Channel** group are displayed.

3 Press the **UP/DOWN ▲▼** button to select the **Manual store**.  
Press the **LEFT/RIGHT ◀▶** button.

**Result:** The **Manual store** menu is displayed.

4 If necessary, indicate the broadcasting standard required by Pressing the **UP/DOWN ▲▼** to select the **Color system**, followed by Press the **LEFT/RIGHT ◀▶** button. The color standards are displayed in the following order :

→ Auto → PAL → SECAM → NT4.43 → NT3.58

5 Select the **Sound system** by pressing the **UP/DOWN ▲▼** button, and followed by pressing the **LEFT/RIGHT ◀▶**. The sound standards are displayed in the following order. :

→ BG → DK → I → M

6 Press the **UP/DOWN ▲▼** button to select the **Store**.

7 Press the **LEFT/RIGHT ◀▶** button to select the **OK**.

## Manual Storing of Channels

- | 8  | If you...  | Then press the ...  |
|----|--|---|
|    | Know the number of the the channel to be stored  | <ul style="list-style-type: none"> <li>◆ <b>UP/DOWN ▲▼</b> button to select <b>Channel</b></li> <li>◆ <b>LEFT/RIGHT ◀▶</b> to indicate the required number</li> </ul> |
|    | Do not know the channel the numbers  | <ul style="list-style-type: none"> <li>◆ <b>UP/DOWN ▲▼</b> button to select <b>Search</b></li> <li>◆ <b>LEFT/RIGHT ◀▶</b> to start the search</li> </ul>              |
|    | <b>Result:</b> The tuner scans the frequency range until the first channel or the channel that you selected is received on your screen.        |   |
| 9  | To assign a programme number to a channel, select the <b>Prog.No.</b> Press the <b>LEFT/RIGHT ◀▶</b> button until you find the correct number. |   |
| 10 | Press the <b>UP/DOWN ▲▼</b> button to select the <b>Store</b> .  |   |
| 11 | Press the <b>LEFT/RIGHT ◀▶</b> button to select the <b>OK</b> .  |   |
| 12 | To store the channel and associated programme number, press the <b>MENU</b> button.  |   |
| 13 | Repeat Steps 10 to 15 for each channel to be stored.   |   |

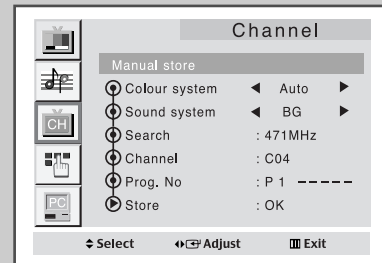
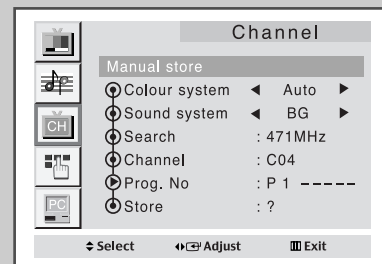
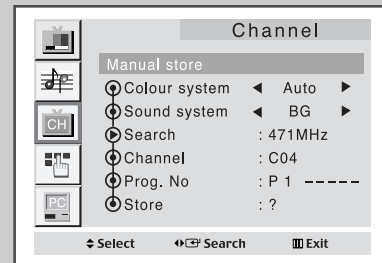
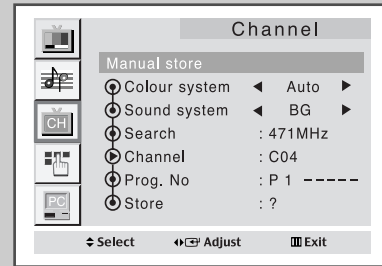

## Assigning Names to Channels

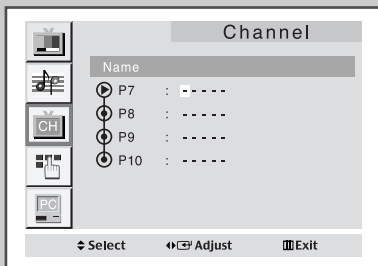
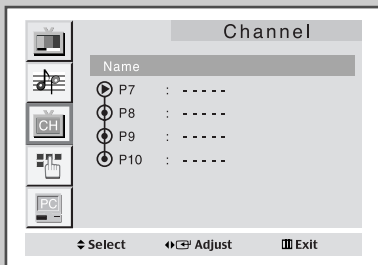
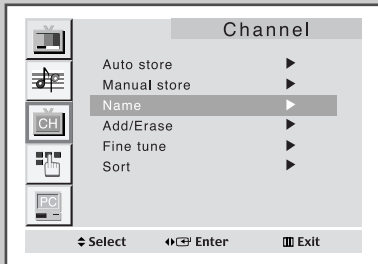
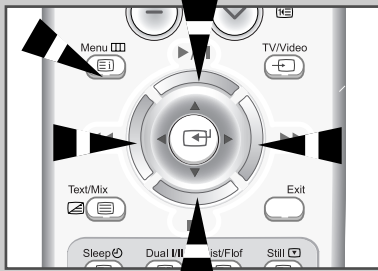

*Channel names will be assigned automatically when channel information is broadcast. These names can be changed, allowing you to assign new names.*

- 1 Press the **MENU** button.

Result: The main menu is displayed.

- 2 Press the **UP/DOWN ▲▼** button to select the **Channel1**.  
Press the **LEFT/RIGHT ◀▶** button.

Result: The options available in the **Channel1** group are displayed.

- 3 Press the **UP/DOWN ▲▼** button to select the **Name**.  
Press the **LEFT/RIGHT ◀▶** button.

Result: The **Name** menu is displayed with the current channel automatically selected.

- 4 If necessary, select the channel to be assigned a new name by Pressing the **UP/DOWN ▲▼** button.

- 5 Press the **LEFT/RIGHT ◀▶** button.

Result: Arrow indications are displayed around the name box.

- 6 **To...** **Then press the...**

Select a letter, number or symbol **UP/DOWN ▲▼** button

Move on the next letter **RIGHT ▶** button

Move back the previous letter **LEFT ◀** button

- The characters available are:
- ◆ Letters of the alphabet (A ... Z)
  - ◆ Numbers (0 ... 9)
  - ◆ Special characters (., -, space)

- 7 You can have each channel newly named.

- 8 When you have finished entering the name, press the **MENU** button to confirm the name.

## Skipping Unwanted Channels

*You can exclude the channels of your choice from the channel scan operation. When you scan through the stored channels, those you have chosen to skip are not displayed.*

*All channels that you do not specifically choose to skip are displayed during scanning.*

- 1 Press the **MENU** button.  
Result: The main menu is displayed.
- 2 Press the **UP/DOWN ▲▼** button to select the **Channel1**.  
Press the **LEFT/RIGHT ◀▶** button.  
Result: The options available in the **Channel1** group are displayed. The **Channel1** menu is displayed.
- 3 Press the **UP/DOWN ▲▼** button to select the **Add/Erase**.  
Press the **LEFT/RIGHT ◀▶** button.  
Result: The **Add/Erase** menu is displayed.
- 4 Press the **UP/DOWN ▲▼** button to select the required channel.
- 5 To add or erase the desired channel by pressing the **LEFT/RIGHT ◀▶** button.
- 6 When you have finished adding and erasing channels, press the **MENU** button repeatedly to return to normal viewing.

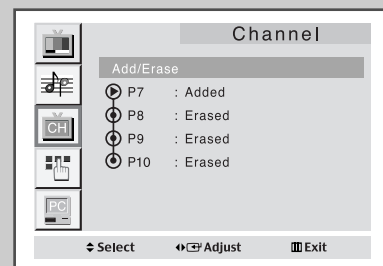
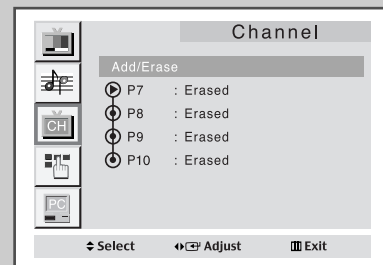
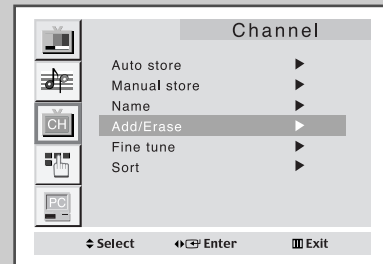
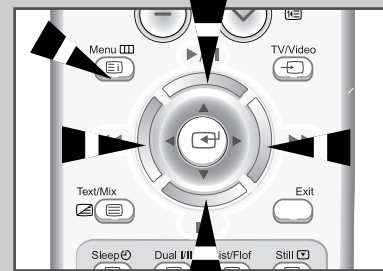

## Fine Tuning Channels

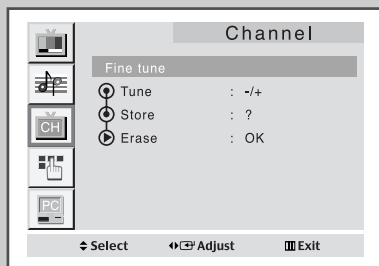
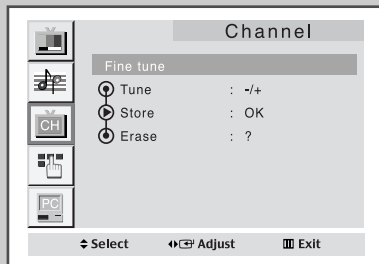
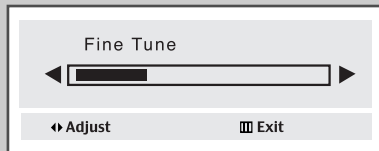
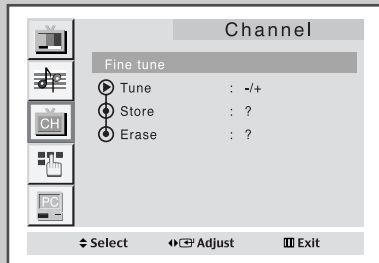
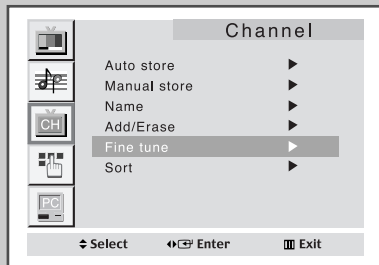

*Use fine tuning to manually adjust a particular channel for optimal reception.*

- 1 Press the **MENU** button

Result: The main menu is displayed.

- 2 Press the **UP/DOWN ▲▼** button to select the **Channel1**.  
Press the **LEFT/RIGHT ◀▶** button.

Result: The options available in the **Channel1** group are displayed.

- 3 Press the **UP/DOWN ▲▼** button to select the **Fine Tune**.  
Press the **LEFT/RIGHT ◀▶**.

- 4 Press the **LEFT/RIGHT ◀▶** button to adjust the fine tuning.

- 5 Press the **UP/DOWN ▲▼** button to select the **Store**.

- 6 Press the **LEFT/RIGHT ◀▶** button to select the **OK**.

- 7 **To reset the fine tuning.**

Press the **UP/DOWN ▲▼** button to select the **Erase**, then press the **LEFT/RIGHT ◀▶** to select the **OK**.

## Changing the Picture Standard

You can use your remote control to select the type of picture which best corresponds to your viewing requirements. The following picture effects are available:

- ◆ Custom, Dynamic, Standard, Movie.

To select the required picture effect, simply press the **P.STD**(+) button on the remote control.

-  You can also set these options via the **Adjust** option in the **Picture** group. If you change the **Contrast**, **Brightness**, **Sharpness**, **Colour**, **Tint** (NTSC only) or **Colour tone** settings on the **Picture** menu, the **Custom** option is selected automatically.



## Adjusting the Picture Settings

Your TV has several settings which allow you to control picture quality:

- ◆ Contrast, Brightness, Sharpness, Colour, Tint (NTSC only), Colour tone

- 1 Press the **MENU** button.  
**Result:** The options available in the **Picture** group are displayed.
- 2 Press the **LEFT/RIGHT** ◀▶ button.
- 3 Press the **UP/DOWN** ▲▼ button to select the required item you want change.  
➤ When select the Mode to **Custom**, the **Adjust** menu is displayed.
- 4 

To adjust the...	Press the...
◆ Contrast	◆ <b>LEFT/RIGHT</b> ◀▶ button.
◆ Brightness	
	<b>Result:</b> The horizontal bar is displayed.
◆ Sharpness	
◆ Colour	
◆ Tint (NTSC only)	
◆ Colour tone	◆ <b>LEFT/RIGHT</b> ◀▶ button.
	<b>Result:</b> You select the required option (Cool2, Cool1, Normal, Warm1, Warm2).
- 5 When you are satisfied with the settings, press the **MENU** button repeatedly to return to normal viewing.

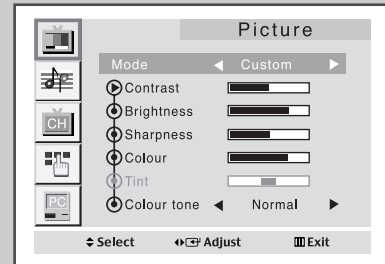

## Selecting the Picture Format



*You can select the picture format which best corresponds to your viewing requirements by simply pressing the P.SIZE button.*

*The following picture formats are available in the order given:*

**Auto wide → Wide → Panorama → Zoom1 → Zoom2 → 4:3**

Picture format	Description
<b>Autowide</b>	The screen size is automatically adjusted when entering a PAL Plus signal(WSS).
<b>Wide</b>	Setting for the 16:9 screen format
<b>Panorama</b>	Use this mode for the wide aspect ratio of a Panorama picture <i>Note:</i> Not available in 480p, 720p and 1080i mode.
<b>Zoom (1,2)</b>	Expansion of a 16:9 picture to full screen format.
<b>4:3</b>	Setting for normal 4:3 format.

## Freezing the Picture



*Press the STILL button to freeze a moving picture into a still one. Press the again to cancel.*



## Adjusting the Volume

*You can adjust the volume using your remote control.*

To...	hold down the...
Increase the volume	▶ button.  <u>Result:</u> A horizontal bar is displayed and the volume increases until you release the button. The cursor moves to the right to indicate the volume.
Decrease the volume	◀ button.  <u>Result:</u> A horizontal bar is displayed and the volume decreases until you release the button. The cursor moves to the left to indicate the volume.

- Additional sound adjustments are available on your TV. For further details, refer to pages 25 to 30.

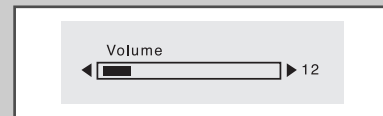

## Switching the Sound Off Temporarily

*You can switch the sound off temporarily.*

**Example:** *You wish to answer the telephone.*

- Press the **MUTE** (🔇) button.  
Result: The sound is switched off and "Mute" is displayed.
- When you wish to turn the sound back on, press the **MUTE** (🔇) button again or either of the volume buttons.  
Result: The sound comes back on at the same volume as before and the "Mute" indication disappears.



## Selecting the Sound Standard



You can use your remote control to select the type of special sound effect to be used when watching a given broadcast. The following sound effects are available:

- ◆ Custom, Standard, Music, Movie, Speech.

To select the required sound effect, simply press the **S.STD** ( ) button on the remote control.

 You can also set these options via the **Equalizer** in the **Sound** group.

## Adjusting the Sound Settings

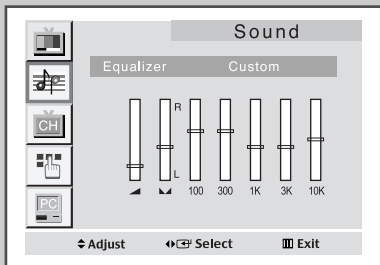
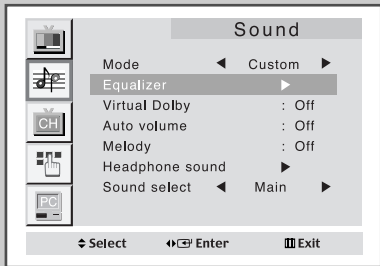

The following settings can be adjusted to suit your personal preferences. The following settings are available:

- 1 Press the **MENU** button.  
Result: The main menu is displayed.

---

  - 2 Press the **UP/DOWN** ▲▼ button to select the **Sound**. Press the **LEFT/RIGHT** ◀▶ button.  
Result: The options available in the **Sound** group are displayed.

---

  - 3 Press the **UP/DOWN** ▲▼ button to select the **Equalizer**. When select the mode to **Custom**, the **Equalizer** menu is displayed.

---

  - 4 Press the **LEFT/RIGHT** ◀▶ button.  
Result: The **Equalizer** menu is displayed.
- | To...                        | Press the...             |
|------------------------------|--------------------------|
| Change a setting             | <b>UP/DOWN</b> ▲▼ button |
| Move to the next setting     | <b>RIGHT</b> ▶ button    |
| Move to the previous setting | <b>LEFT</b> ◀ button     |
- 5 When you are satisfied with the settings, press the **MENU** button repeatedly to return to normal viewing.

 If you make any changes to the **Equalizer** settings, the sound standard is automatically switched to **Custom**.



## Virtual Dolby

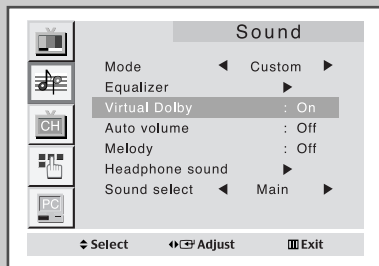
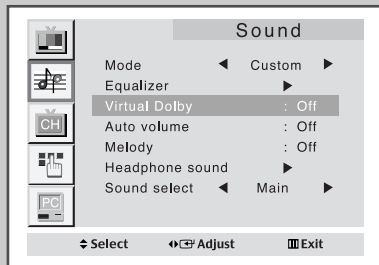

*This feature allows the TV's L/R speakers to provide a home Theater-like Dolby effect. The center and surround sounds are mixed into the L/R speakers.*

- 1 Press the **MENU** button.

Result: The main menu is displayed.

- 2 Press the **UP/DOWN ▲▼** button to select the **Sound**.  
Press the **LEFT/RIGHT ◀▶** button.

Result: The options available in the **Sound** group are displayed.

- 4 Press the **UP/DOWN ▲▼** button to select the **Virtual Dolby**.

- 5 Select the required option by pressing the **LEFT/RIGHT ◀▶** button.

- 6 Press the **MENU** button to return to normal viewing.

## Adjusting the Volume Automatically

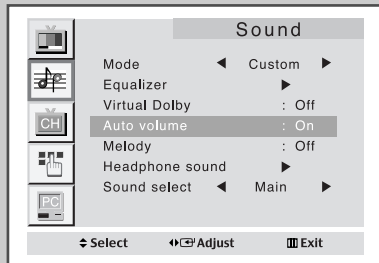
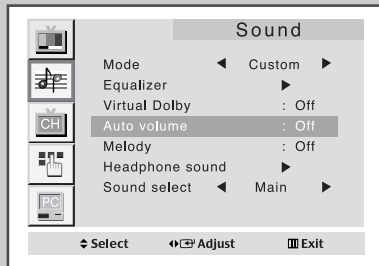

*Each broadcasting station has its own signal conditions, and so it is not easy for you to adjust the volume every time the channel is changed. Auto volume lets you automatically adjust the volume of the desired channel by lowering the sound output when the modulation signal is high or by raising the sound output when the modulation signal is low.*

- 1 Press the **MENU** button.

Result: The main menu is displayed.

- 2 Press the **UP/DOWN ▲▼** button to select **Sound**.  
Press the **LEFT/RIGHT ◀▶** button.

Result: The options available in the **Sound** group are displayed.

- 3 Press the **UP/DOWN ▲▼** button to select the **Auto volume**.

- 4 Select the required option by pressing the **LEFT/RIGHT ◀▶** button.

- 5 Press the **MENU** button to return to normal viewing.

## Connecting Headphones

*You can connect a set of headphones to your TV if you wish to watch a TV programme without disturbing the other people in the room.*

Plug a set of headphones into the 3.5 mm mini-jack socket on the panel of the TV.

**Result:** The sound is heard through the headphones.

- For further details on how to set your headphone preferences, refer to the section below.

- Prolonged use of headphones at a high volume may damage your hearing.
- You will not receive sound from the speakers when you connect headphones to the system.

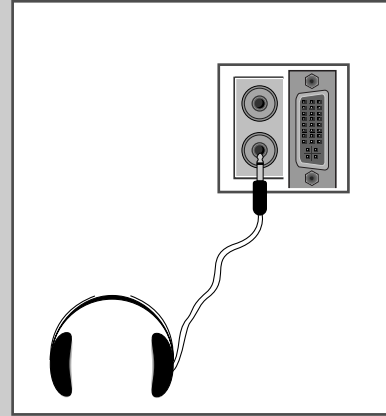

## Adjusting Your Headphone Preferences

*You can adjust the headphone settings to suit your preferences. The following headphone settings are available:*

- ◆ *Volume, Balance, Bass, Treble.*

- 1 Press the **MENU** button.

**Result:** The main menu is displayed.

- 2 Press the **UP/DOWN ▲▼** button to select **Sound**. Press the **LEFT/RIGHT ◀▶** button.

**Result:** The options available in the **Sound** group are displayed.

- 3 Press the **UP/DOWN ▲▼** button to select the **Headphone sound**. Press the **LEFT/RIGHT ◀▶** button.

**Result:** The **Headphone sound** menu is displayed.

To...	Then...
Change the option	Press the <b>UP/DOWN ▲▼</b> button.
Change a setting	Press the <b>LEFT/RIGHT ◀▶</b> button.
Confirm the changes	Press the <b>MENU</b> button.

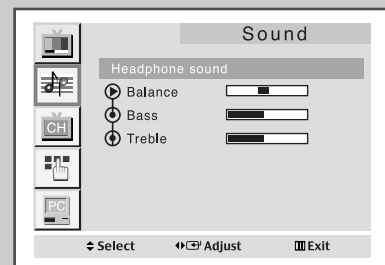
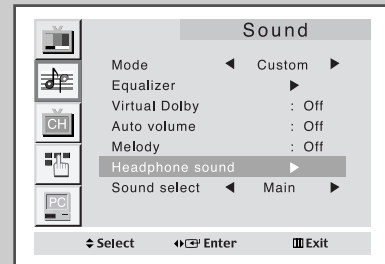

## Selecting the Sound

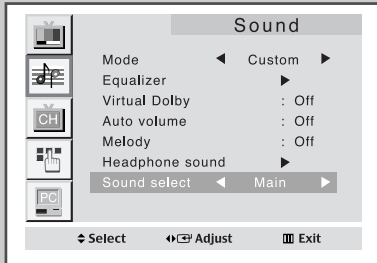
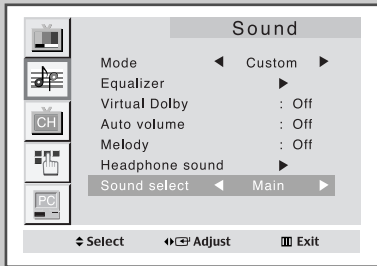

- 1 Press the **MENU** button.

**Result:** The main menu is displayed.

- 2 Press the **UP/DOWN ▲▼** button to select **Sound**.  
Press the **LEFT/RIGHT ◀▶** button.

**Result:** The options available in the **Sound** group are displayed.

- 3 Press the **UP/DOWN ▲▼** button to select the **Sound select**.

- 4 Select the required option by pressing the **LEFT/RIGHT ◀▶** button.

- 5 Press the **MENU** button to return to normal viewing.

➤ The sound of subscreen can be selected only while the PIP functions is operating.

## Picture in Picture Feature

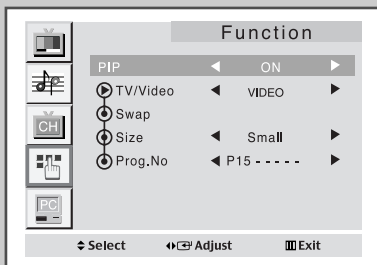
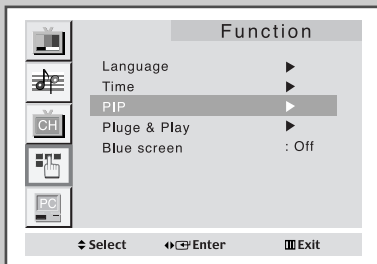

*You can display a "Picture-in-Picture screen" within the main picture of TV programme or Video input. In this way you can watch or monitor TV programme or the Video input from any connected equipment while watching TV or other Video input. For information about connection of other equipment, refer to pages 41 and 42.*

- 1 Press the **MENU** button.

**Result:** The main menu is displayed.

- 2 Press the **UP/DOWN ▲▼** button to select **Function**.  
Press the **LEFT/RIGHT ◀▶** button.

**Result:** The options available in the **Function** group are displayed.

- 3 Press the **UP/DOWN ▲▼** button to select **PIP**.  
Press the **LEFT/RIGHT ◀▶** button.

**Result:** The options available in the **PIP** group are displayed.

- 4 To activate the PIP feature, set the **PIP** to **on** by pressing the **LEFT/RIGHT ◀▶** button.

- 5 Press the **UP/DOWN ▲▼** button to select **TV/VIideo**.  
Then, select a source of the sub picture by pressing the **LEFT/RIGHT ◀▶** button.

The sources are displayed in the following order:

TV → VIDEO → S-VIDEO → COMP1 → COMP2

- 6 To interchange the main picture and the sub picture, select the **Swap** option and press the **LEFT/RIGHT ◀▶** button.

- 7 Press the **UP/DOWN ▲▼** button to select **Size**. Then, select a size of the sub to **Double Screen1**, **Double Screen2** or **Small** by pressing the **LEFT/RIGHT ◀▶** button.
- 8 Press the **UP/DOWN ▲▼** button to select **Prog.No.** You can select the channel that you want to view through sub picture by pressing the **LEFT/RIGHT ◀▶** button.
- 9 To return to normal viewing, press the **MENU** button.

#### Remote-control functions while "PIP" is "On":

Features	Description
<b>PIP ON</b>	Used to operate ON/OFF function of PIP directly.
<b>SWAP</b>	Used to interchange the main picture and the sub picture. <ul style="list-style-type: none"> <li>➤ When the main picture is in the Video mode and the sub picture is in the TV mode, you might not hear the sound of main picture when pressing the <b>SWAP</b> button after changing the sub picture channel. At this time, reselect the main picture channel.</li> <li>➤ The swap function will not operate in PC Mode.</li> </ul>
<b>LOCATE</b>	Used to move the sub picture counterclockwise.
<b>P ▼/▲</b>	Used to select the channel of sub picture.
<b>SIZE</b>	Used to select the type of sub picture ( <b>Double Screen1</b> , <b>Double Screen2</b> , <b>Small</b> ). <ul style="list-style-type: none"> <li>➤ The PC Mode can be setup in the main display only, and the size of the sub-display small size.</li> </ul>
<b>SOURCE</b>	Used to assign a source of sub picture ( <b>TV</b> , <b>VIDEO</b> , <b>S-VIDEO</b> , <b>COMP1</b> , <b>COMP2</b> ).



## Setting the Blue Screen Mode

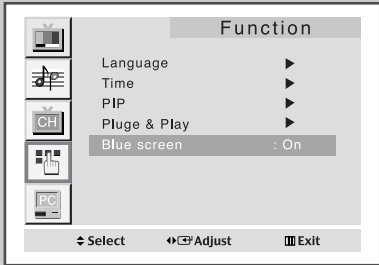

*If no signal is being received or the signal is very weak, a blue screen automatically replaces the noisy picture background.*

*If you wish to continue viewing the poor picture, you must set the "Blue screen" mode to "Off".*

- 1 Press the **MENU** button.  
Result: The main menu is displayed.

---

- 2 Press the **UP/DOWN ▲▼** button to select the **Function**. Press the **LEFT/RIGHT ◀▶** button.  
Result: The options available in the **Function** group are displayed.

---

- 3 Press the **UP/DOWN ▲▼** button to select the **Blue screen**.

---

- 4 Select the required option by pressing the **LEFT/RIGHT ◀▶** button.

---

- 5 Press the **MENU** button repeatedly to return to normal viewing.

## Setting the Sleep Timer



**Sleep Timer 30**

*You can select a time period of between 30 and 180 minutes after which the television automatically switches to Standby mode by pressing the "SLEEP" button.*

- 1 Press the **SLEEP** button on the remote control.  
Result:  

If the sleep timer is...	The screen displays...
Already set	Time remaining before the television will be placed in standby mode.
Not yet set	Word "Off".

---

- 2 Press the **SLEEP** button repeatedly and cycle through the preset time intervals (30, 60, 90, 120, 150, 180).  
Result: The TV automatically switches to standby mode when the timer reaches 0.

---

- 3 To cancel the sleep timer function, press the **SLEEP** button repeatedly and select "Off".



## Setting and Displaying the Current Time

You can set the TV's clock so that the current time is displayed when you press the "DISPLAY" button.

You must also set the time if you wish to use the automatic On/Off timers.

- The clock setting will be re-activated when pressing the "⏻" (ON/OFF) button on the front panel.

- 1 Press the **MENU** button.

Result: The main menu is displayed.

- 2 Press the **UP/DOWN ▲▼** button to select the **Function**.  
Press the **LEFT/RIGHT ◀▶** button.

Result: The options available in the **Function** group are displayed

- 3 Press the **UP/DOWN ▲▼** button to select the **Time**.  
Press the **LEFT/RIGHT ◀▶** button.

Result: The "Time" menu is displayed with the 'Clock' selected.

- | 4 To...                    | Press the...                 |
|----------------------------|------------------------------|
| Move to the hour or minute | <b>LEFT/RIGHT ◀▶</b> button. |
| Set the hour or minute     | <b>UP/DOWN ▲▼</b> button.    |

- 5 When you have finished, press the **MENU** button or, press the **MENU** button repeatedly to return to normal viewing.

- | 6 To display the... | Press the "DISPLAY" button... |
|---------------------|-------------------------------|
| Channel information | Once.                         |
| Current time        | Twice.                        |

- **Absent power off?**  
When you set the timer on, your television will be turned off if you do not operate any controls during 3 hours after you turn on the TV. This 'Absent power off' function is available in only 'Timer on' situation. This function will prevent the leakage accident or dissipation caused by the occasion that your TV will be left in turned on situation for a long time due to 'Timer on'. (when you are away on holiday for example)

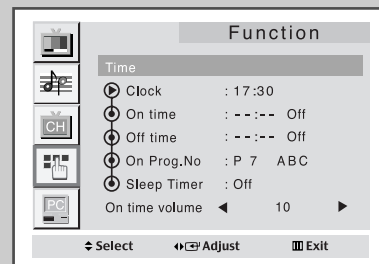
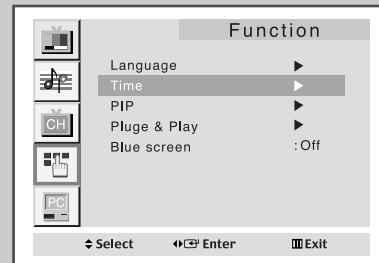

## Switching the Television On and Off Automatically

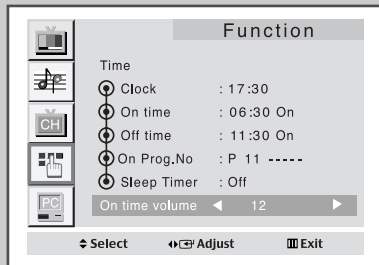
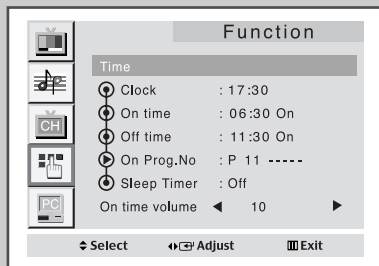
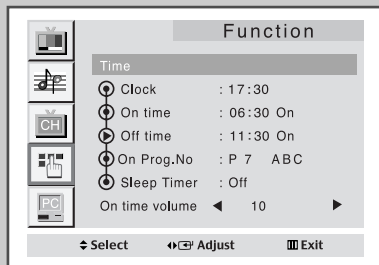
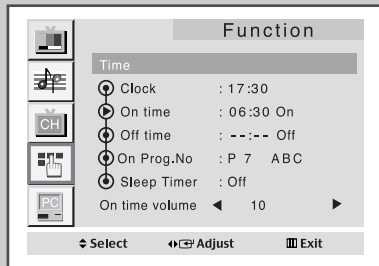
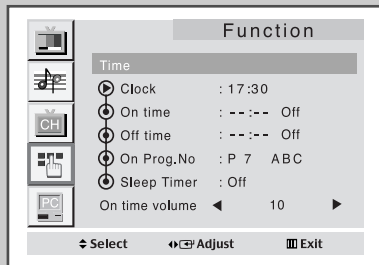

You can set the On/Off timers so that the TV will:

- ◆ Switch on automatically and tune to the channel of your choice at the time you select
- ◆ Switch off automatically at the time you select

➤ The first step is to set the TV's clock (refer to "Setting and Displaying the Current Time" on the previous page).

1 Press the **MENU** button.

Result: The main menu is displayed.

2 Press the **UP/DOWN ▲▼** button to select the **Function**. Press the **LEFT/RIGHT ◀▶** button.

Result: The options available in the **Function** group are displayed.

3 Press the **UP/DOWN ▲▼** button to select the **Time**. Press the **LEFT/RIGHT ◀▶** button.

Result: The **Time** menu is displayed.

4 Press the **UP/DOWN ▲▼** button to select the **On time**.

5 Set the time at which you wish the TV to be switched On.

To...	Press the...
Move to the hour or minute	<b>LEFT/RIGHT ◀▶</b> button
Adjust the hour or minute	<b>UP/DOWN ▲▼</b> button
Move to the Off	<b>LEFT/RIGHT ◀▶</b> button
Set the On or Off	<b>UP/DOWN ▲▼</b> button

6 In the same way, set the time at which you wish the TV to be switched Off.

7 If you want set the channel when the TV turns on, press the **UP/DOWN ▲▼** button to select the **On Prog.No.** Press the **LEFT/RIGHT ◀▶** button to select channel.

8 If you want set the volume level when the TV turns on, press the **UP/DOWN ▲▼** button to select the **On time volume**. Press the **LEFT/RIGHT ◀▶** button to adjust volume level.

9 When you have finished setting the On/Off time, On Prog. No or On time volume, press the **MENU** button repeatedly to return to normal viewing.

## Connecting to the PC Input

- The PC(VIDEO/AUDIO-ST) connectors are used for interfacing with your PC.

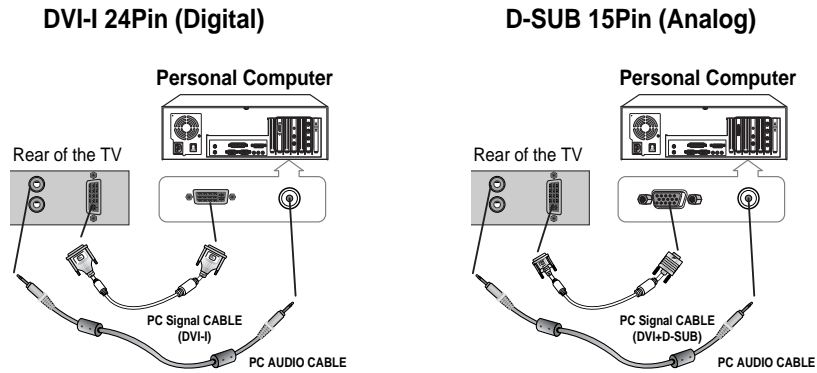

### ➤ How to Set up Your PC Software ( Based on Windows 2000 or Windows XP )

The Windows display-settings for a typical computer are shown below. But the actual screens on your PC will probably be different, depending upon your particular version of Windows and your particular video card. But even if your actual screens look different, the same, basic set-up information will apply in almost all cases. (If not, contact your computer manufacturer or Samsung Dealer.)

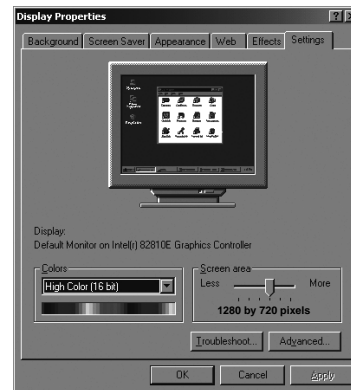
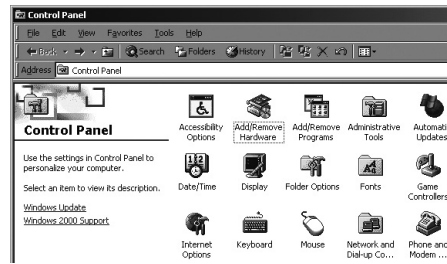
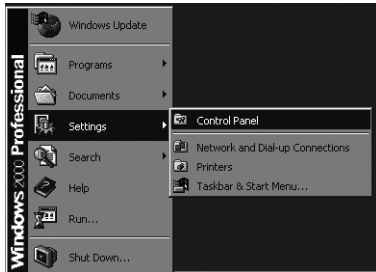

First, click on "Settings" on the Windows start menu.  
While "Settings" is highlighted, move the cursor so that "Control Panel" is highlighted.  
When the control panel screen appears, click on "Display" and a display dialog-box will appear.  
Navigate to the "Settings" tab on the display dialog-box.

The correct setting of size (resolution) is "1280x 720pixels".  
If a vertical-frequency option exists on your display settings dialog box, the correct value is "60" or "60 Hz". Otherwise, just click "OK" and exit the dialog box.

- Only black signal is output from a monitor in PC mode.

## Adjusting the Screen Quality

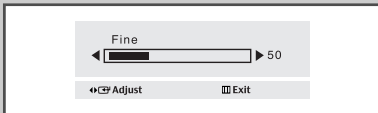
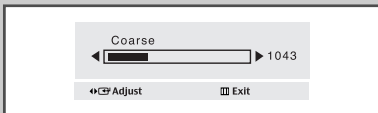
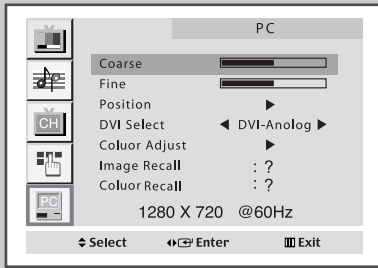

*The purpose of picture quality adjustment is to remove or reduce picture noise. If the noise is not removed by fine tuning alone, then do the frequency adjustments to the utmost and fine tune again. After the noise has been reduced, re-adjust the picture so that it is aligned on the center of screen.*

**Preset to the PC mode by using the PC button.**

- 1 Press the **MENU** button.

**Result:** The main menu is displayed.

- 2 Press the **UP/DOWN ▲▼** button to select the **PC**. Press the **LEFT/RIGHT ◀▶** button.

**Result:** The options available in the **PC** group are displayed.

- 3 Press the **UP/DOWN ▲▼** button to select the **Coarse** or **Fine**.

- 4 Press the **LEFT/RIGHT ◀▶** button to adjust the screen quality, vertical stripes appears or the picture may be blurry.

- 5 When you are satisfied with the settings, press the **MENU** button repeatedly to return to normal viewing.

➤ Coarse and Fine don't work in DVI-Digital Mode.

## Changing the Screen Position

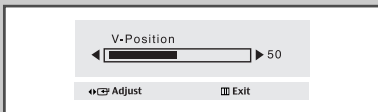
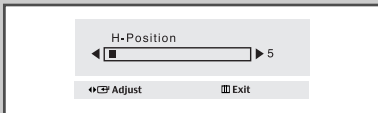
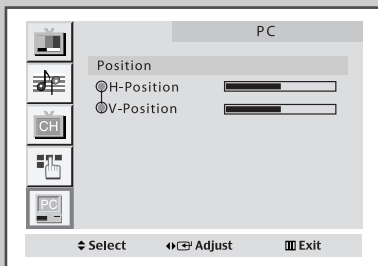
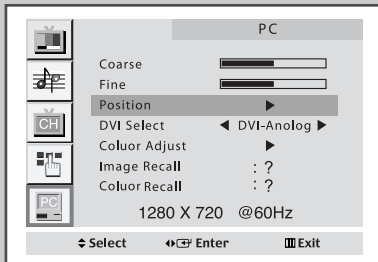

**Preset to the PC mode by using the PC button.**

- 1 Press the **MENU** button.

**Result:** The main menu is displayed.

- 2 Press the **UP/DOWN ▲▼** button to select **PC**. Press the **LEFT/RIGHT ◀▶** button.

**Result:** The options available in the **PC** group are displayed.

- 3 Press the **UP/DOWN ▲▼** button to select the **Position** and select the **H-Position** or **V-Position**.

- 4 Press the **LEFT/RIGHT ◀▶** button to adjust the required position.

- 5 Press the **MENU** button repeatedly to return to normal viewing.

**To initialize the image adjustment.**

- 1 After steps 1-2 above are completed, press the **UP/DOWN ▲▼** button to select the **Image Recall**.

- 2 Press the **LEFT/RIGHT ◀▶** button to initialize the image adjustment.

## Changing the Screen Colour Standard

*Preset to the PC mode by using the PC button.*

- 1 Press the **MENU** button.  
**Result:** The main menu is displayed.
- 2 Press the **UP/DOWN ▲▼** button to select **PC**.  
Press the **LEFT/RIGHT ◀▶** button.  
**Result:** The options available in the **PC** group are displayed.
- 3 Press the **UP/DOWN ▲▼** button to select the **Colour Adjust**, then press the **LEFT/RIGHT ◀▶** button.  
**Result:** You can select "Custom", "Colour1", "Colour2" or "Colour3".
- 4 Press the **MENU** button repeatedly to return to normal viewing.

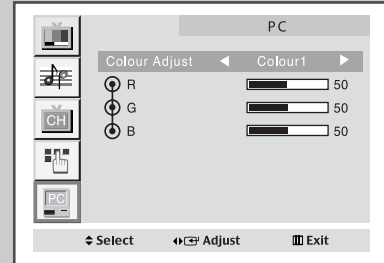
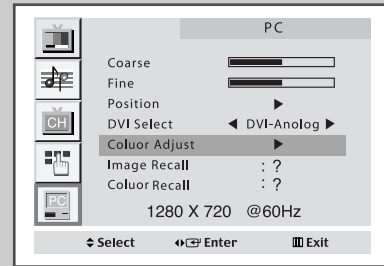

## Adjusting the Screen Colour Settings

*Preset to the PC mode by using the PC button.*

- 1 Press the **MENU** button.  
**Result:** The main menu is displayed.
- 2 Press the **UP/DOWN ▲▼** button to select **PC**.  
Press the **LEFT/RIGHT ◀▶** button.  
**Result:** The options available in the **PC** group are displayed.
- 3 Press the **UP/DOWN ▲▼** button to select the **Colour Adjust**, then press the **LEFT/RIGHT ◀▶** button.
- 4 Press the **UP/DOWN ▲▼** button to select the required item you want adjust.
- 5 **To adjust the... Press the...**

◆ R	◆ LEFT/RIGHT ◀▶ button.
◆ G	
◆ B	
- 6 Press the **MENU** button repeatedly to return to normal viewing.

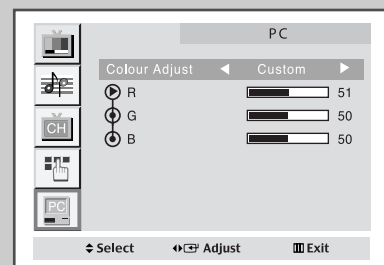
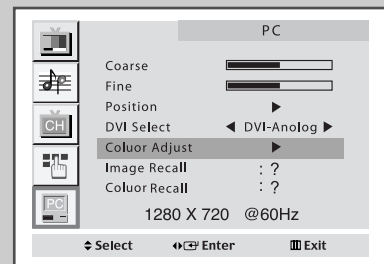

**To initialize the Colour adjustment.**

- 1 After steps 1~2 above are completed, press the **UP/DOWN ▲▼** button to select the **Colour Recall**.
- 2 Press the **LEFT/RIGHT ◀▶** button to initialize the Colour adjustment.

## Teletext Decoder

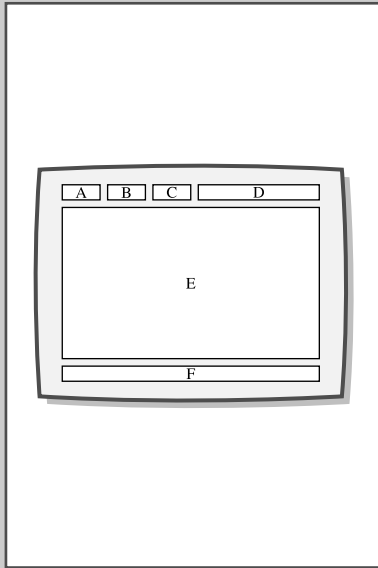

Most TV channels carry "teletext," pages of written information that provide information such as:

- ◆ **Television programme times**
- ◆ **News bulletins**
- ◆ **Weather forecasts**
- ◆ **Sports results**
- ◆ **Subtitles for the hard of hearing**

The teletext pages are organized according to six categories:

Part	Contents
A	Selected page number.
B	Broadcasting station identity.
C	Current page number or search status.
D	Date and time.
E	Text.
F	Status information.

## Displaying Teletext Information

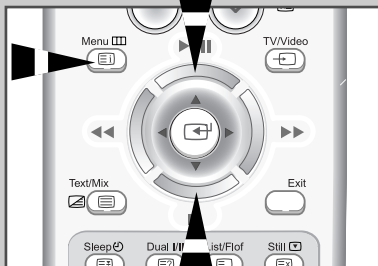

You can display teletext information at any time, but signal reception must be good. Otherwise:

- ◆ **Information may be missing**
- ◆ **Some pages may not be displayed**

To activate the teletext mode and display the contents page:

- 1 Using the **P^** ( ) or **P^** ( ) button, select the channel providing the teletext service.
- 2 Press the **Text/Mix** ( ) button to activate the teletext mode.

**Result:** The contents page (page 100) is displayed. It can be redisplayed at any time by pressing the **Menu** ( ) button.

- 3 To display the actual broadcast simultaneously with the teletext page, press the **Text/Mix** ( ) button.
- 4 To return to normal viewing press the **Still** ( ) button.
- 5 Press the **Text/Mix** ( ) button again to exit from the TTX display.

➤ If any broken character appears while TTX is being viewed, make sure that the TTX language is identical with the language in the "Function" menu mode. If both languages are different, select the same language with the TTX language on the "Function" menu.

## Selecting a Specific Teletext Page

**Press the number buttons on the remote control to enter the page number directly:**

- 1 Enter the three-digit page number listed in the contents by pressing the corresponding numeric buttons.

**Result:** The current page counter is incremented and the page is then displayed.

- 2 If the selected page is linked with several secondary pages, the secondary pages are displayed in sequence. To freeze the display on a given page, press the **Sleep** (⏸). Press the **Sleep** again to resume.

- 3 Using the various display options:

To display...	Press the...
◆ Both teletext information and the normal broadcast	<b>Text/Mix</b> (⏸ / ⏸)
◆ Hidden text (answers to quiz games, for example)	<b>Dual I/II</b> (⏸)
◆ The normal screen	<b>Dual I/II</b> (⏸) again
◆ A secondary page, by entering its 4-digit number	<b>Subpage</b> (⏸)
◆ The next page	<b>P^</b> (⏸)
◆ The previous page	<b>P^</b> (⏸)
◆ Double-size letters in the: <ul style="list-style-type: none"> <li>◆ Upper half of the screen</li> <li>◆ Lower half of the screen</li> </ul>	<b>Size</b> (⏸) <ul style="list-style-type: none"> <li>◆ Once</li> <li>◆ Twice</li> </ul>
◆ Normal screen	◆ Three times



## Using FLOF to Select a Teletext Page

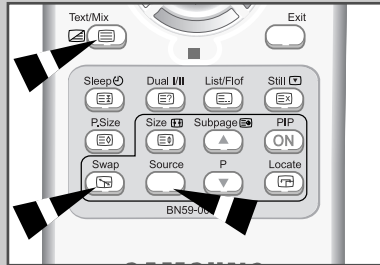

*The various topics included in the teletext pages are colour-coded, and can be selected by pressing the coloured buttons on the remote control.*

- 1 Display the teletext contents page by pressing the **Text/Mix** (  ) button.
- 2 Press the coloured button corresponding to the topic that you wish to select (The available topics are listed on the status information line).

**Result:** The page is displayed with additional colour-coded information that can be selected in the same way.

- | 3 To display the: | Press the:    |
|-------------------|---------------|
| Previous page     | Red button.   |
| Next page         | Green button. |
- 4 When you have finished, press the **Still** (  ) button to return to the normal broadcast.

## Storing Teletext Pages

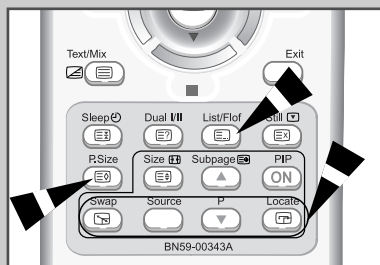

*Up to four teletext pages can be stored.*

- 1 Select the LIST mode.
 

**Result:** Four 3-digit numbers are displayed in different colours at the bottom of the screen.
- 2 Press the coloured button corresponding to the page that will be replaced.
- 3 Enter the new page number using the numeric buttons.
- 4 Repeat steps 2 and 3 for each page to be stored, using a different coloured button each time.
- 5 Press the **P.Size** (  ) button until the corresponding blocks blink.

- The List/Flof (  ) button is used to switch between:
- ◆ LIST mode
  - ◆ FLOF mode



## Connecting to the Component Input/Outputs

- COMPONENT1 is used for equipment with an Y,Pb,Pr output, such as DVD Player devices and Satellite receiver.

### *Rear of TV*

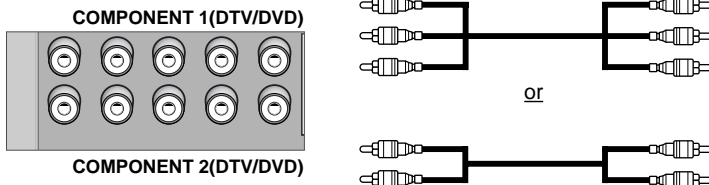

### Video disc player



### Satellite receiver

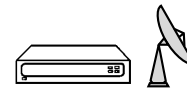

## Connecting to the RCA Input

- The RCA (video + audio L and R) connectors are used for equipment such as camcorders, video disc players and some video game devices.

### *Rear of TV*

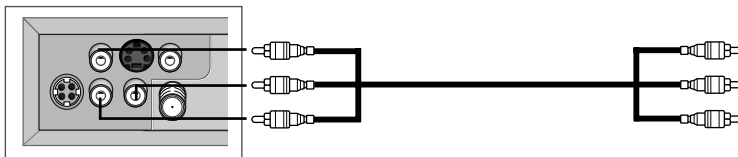

### VCR

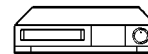

### Camcorder

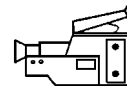

### Video disc player



### Decoder/ Video game device

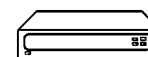

## Connecting to the S-Video Input

- The S-VIDEO/RCA(AUDIO-L+R) connectors are used for equipment with an S-Video output, such as a camcorder or VCR.

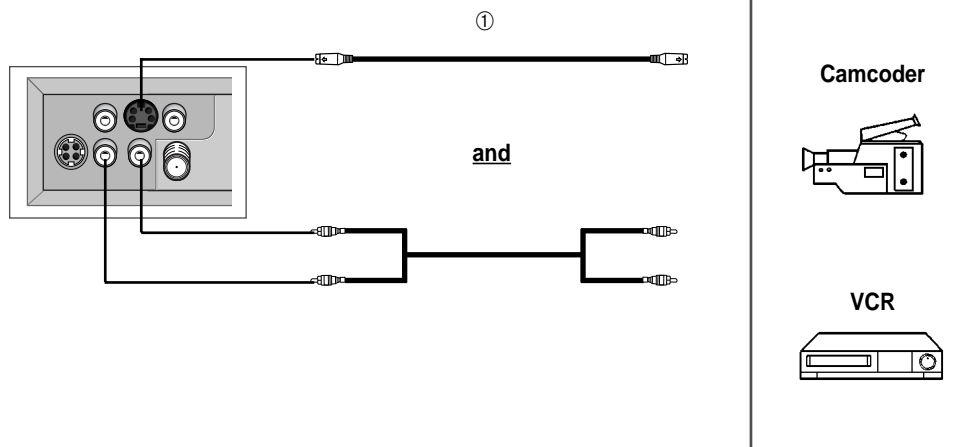

### Rear of the TV



- ① To play pictures and sound both the S-VIDEO and the RCA connections must be used.

## Viewing Pictures From External Sources

*Once you have connected up your various audio and video systems, you can view the different sources by selecting the appropriate input.*

- 1 Check that all the necessary connections have been made.
  - 2 Switch the television on and if necessary, press the **TV/Video** (  ) button one or more times until the required input is displayed.
    - Depending on the source selected, the pictures may appear automatically.
- To watch television programmes again, press the **TV/Video** (  ) button to select the "TV" and select the number of the channel required.

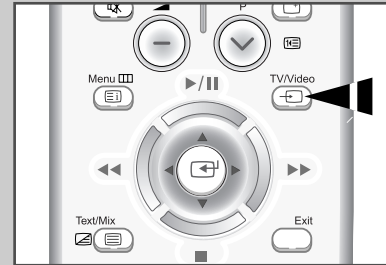

## Troubleshooting: Before Contacting Service Personnel

*Before contacting Samsung after-sales service, perform the following simple checks.*

*If you cannot solve the problem using the instructions below, note the model and serial number of the television and contact your local dealer.*

No sound or picture	<ul style="list-style-type: none"> <li>◆ Check that the mains lead has been connected to a wall socket.</li> <li>◆ Check that you have pressed the "ⓐ" (ON/OFF) button.</li> <li>◆ Check the picture contrast and brightness settings.</li> <li>◆ Check the volume.</li> </ul>
Normal picture but no sound	<ul style="list-style-type: none"> <li>◆ Check the volume.</li> <li>◆ Check whether the <b>MUTE</b> (ⓧ) button has been pressed on the remote control.</li> </ul>
No picture or black and white picture	<ul style="list-style-type: none"> <li>◆ Adjust the colour settings.</li> <li>◆ Check that the broadcast system selected is correct.</li> </ul>
Sound and picture interference	<ul style="list-style-type: none"> <li>◆ Try to identify the electrical appliance that is affecting the television and move it further away.</li> <li>◆ Plug your television into a different mains socket.</li> </ul>
Blurred or snowy picture, distorted sound	<ul style="list-style-type: none"> <li>◆ Check the direction, location and connections of your aerial. This interference is often due to the use of an indoor aerial.</li> </ul>
Remote control malfunctions	<ul style="list-style-type: none"> <li>◆ Replace the remote control batteries.</li> <li>◆ Clean the upper edge of the remote control (transmission window).</li> <li>◆ Check the battery terminals.</li> </ul>
"Check Signal Cable" message.	<ul style="list-style-type: none"> <li>◆ Ensure that the signal cable is firmly connected to the PC sources.</li> <li>◆ Ensure that the PC sources are turned on.</li> </ul>
"Not Supported Mode!" message.	<ul style="list-style-type: none"> <li>◆ Check the maximum resolution and the frequency of the video Adapter.</li> <li>◆ Compare these values with the data in the Display Modes Timing Chart.</li> </ul>
The image is too light or too dark.	<ul style="list-style-type: none"> <li>◆ Adjust the Brightness and Contrast.</li> </ul>
Horizontal bars appear to flicker, jitter or shimmer on the image.	<ul style="list-style-type: none"> <li>◆ Adjust the Fine function.</li> <li>◆ Adjust the Coarse function and then adjust the Fine function.</li> </ul>
Vertical bars appear to flicker, jitter or shimmer on the image.	<ul style="list-style-type: none"> <li>◆ The TV is using its power management system.</li> <li>◆ Move the computer's mouse or press a key on the keyboard.</li> </ul>
Screen is black and power indicator light is steady blinks 1 second.	<ul style="list-style-type: none"> <li>◆ Check that your PC is normally operated, not in the power saving mode, or the signal cable is connected well.</li> </ul>

---

Image is not stable and may appear to vibrate.

- ◆ If the setting is not correct, use your computer utility programme to change the display settings.

---

NOTE: Your TV supports multiscan display functions within the following frequency domain:

- 
- ◆ Horizontal frequency: 30 kHz ~ 61 kHz
  - ◆ Vertical frequency: 56 Hz ~ 75 Hz
  - ◆ Maximum refresh rate: 1280 x 720 @ 60 Hz

---

Image is not centered on the screen.

- ◆ Adjust the horizontal and vertical position.
- 

### Dot Defect

TFT LCD panel manufactured by using advanced semiconductor technology with precision of 99.999% above is used for this product. But the pixels of RED, GREEN, BLUE and WHITE colour seem to be bright sometimes or some of black pixels could be seen.

This is not from bad quality and you can use it without uneasiness.

**The number of TFT-LCD pixels : 2,764,800**

## Display Modes

*If the signal from the system equals to the standard signal mode, the screen is adjusted automatically. If the signal from the system doesn't equal to the standard signal mode, adjust the mode with referring to the Videocard user guide because the screen might not display or only the power LED might be on. For the display modes listed below, the screen image has been optimized during manufacture.*

Mode	Resolution	Horizontal Frequency (kHz)	Vertical Frequency (Hz)	Pixel Clock Frequency (MHz)	Sync Polarity (H/V)
MAC	640×480	35.000	66.667	30.240	- / -
	832×624	49.726	74.551	49.500	+ / +
IBM	640×480	31.469	59.940	25.175	- / -
	720×400	31.469	70.087	28.322	- / +
VESA	640×480	37.861	72.809	31.500	- / -
	640×480	37.500	75.000	31.500	- / -
	800×600	37.879	60.317	40.000	+ / +
	800×600	48.077	72.188	50.000	+ / +
	800×600	46.875	75.000	49.500	+ / +
GTF	1280×720	44.769	60.000	74.841	- / +

## Attaching a wall or Arm mounting Device

*The TV supports VESA mounting standard for use with various VESA mounting devices. To install any VESA mounting device, please follow the instructions given.*

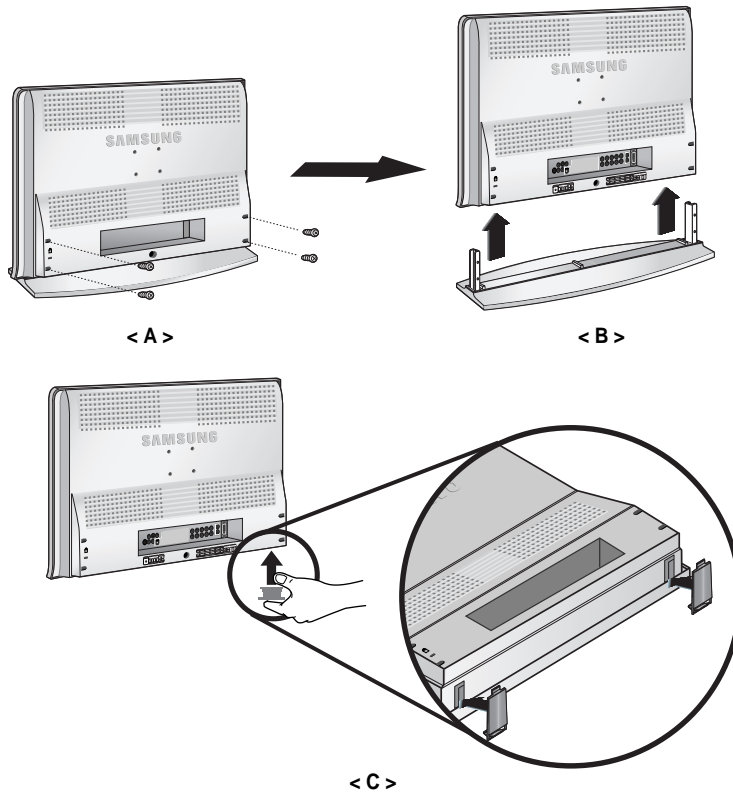

- 1 Remove all cable connected on the TV.
- 2 Remove the four screws and then remove the Stand from the LCD TV. (refer to the picture A&B)  
Remove all cable connected on the TV.
- 3 Push the stand cap until it clicks, as shown in Figure C.
- 4 Connect all cable you removed at step 1.
- 5 Now you are ready to install **Wall/Arm mounting device** depending on your applications.

### Maintenance of YOUR LCD TV

**WARNING:** To avoid risk of electric shock, do not disassemble the TV cabinet (except for gaining access to the cable connectors as described on page 5). Users cannot service the TV. User maintenance is restricted to cleaning as explained below:

Unplug the monitor from the power outlet before cleaning.

- ◆ To clean your flat panel display screen, lightly dampen a soft, clean cloth with water or mild detergent. If possible, use a special screen cleaning tissue or solution suitable for the antistatic coating.
- ◆ To clean the monitor cabinet, use a cloth lightly dampened with a mild detergent.
- ◆ Never use flammable cleaning material to clean your LCD TV or any other electrical apparatus.

## Installing VESA Compliant mounting Device

*Align the mounting interface pad with the holes in the rear cover mounting pad and secure it with the four screws that came with the arm-type base, wall mount hanger or other bases.*

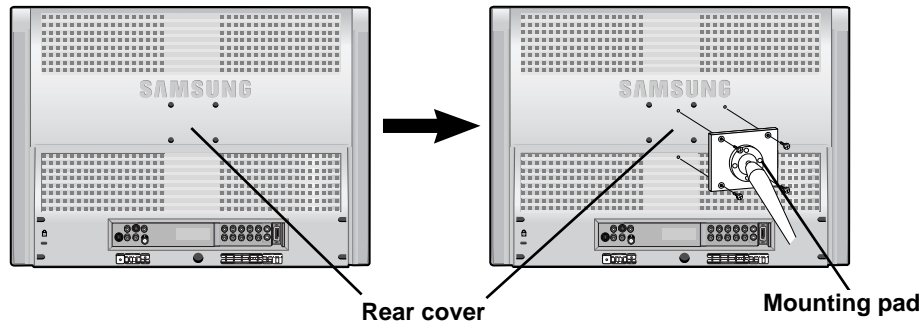

### Wall Mount Instructions

The following instructions apply to a hollow sheet-rock wall only. Tools/Hardware needed - Philips screwdriver, four toggle bolts, 5/8in dia. Drill bit and drill. Contact Ergotron at (800) 888-8458 to purchase the triple pivot direct mount adapter and wall mount bracket kit.

- ◆ LTM225W (22") : No. 47 - 007 - 099 - 02 (Pivot direct mount adapter)  
No. 97 - 101 - 003 - 00 (Wall mount bracket kit)

Align the wall mount bracket on the wall at the desired height, making sure that the bracket will be mounted between the wall studs. Mark the four corner openings and drill four 5/8-dia. holes. Assemble the wall mount kit according to the instructions provided with it. Securely attach Ergotron's flat panel, triple pivot direct mount adapter to the back of the TV using the four 4mm, .7 pitch x 10mm screws provided with the arm. Secure the assembly to the wall using four 3/16 by 3-inch long toggle bolts.



## Kensington Slot

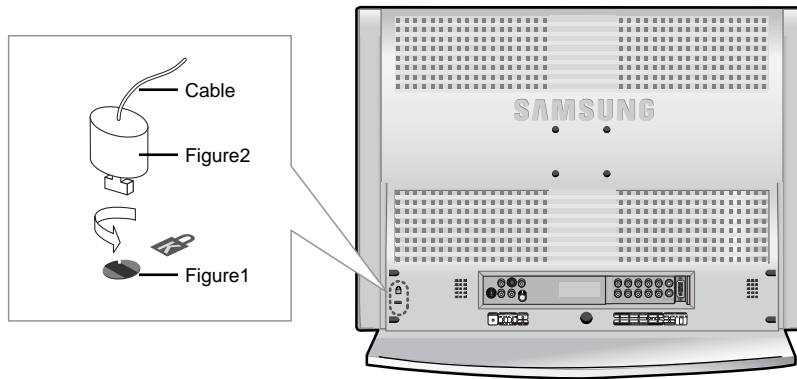

- ◆ *This LCD TV has been designed to apply a burglarproof lock.*
- ◆ *See the figure below for information about where the lock is located and how to use it.*

The Kensington lock is a device used to physically fix the system when using it in a public place. The locking device has to be purchased separately. The appearance and locking method may differ from the illustration depending on the manufacturer. Please refer to the manual provided with the Kensington lock for proper use.

### 1

Insert the locking device into the Kensington slot on the LCD TV (figure 1), and turn it in the locking direction (figure 2).

### 2

Connect the Kensington lock cable.

### 3

Fix the Kensington lock to a desk or a heavy stationary object.



## Specification

Model Name		LS22A13W
Power Consumption	Maximum Power Saving	120W < 5 W
Dimensions/Weight	Unit (WxDxH) : TV body  With stand	23.62 x 2.63 x 17.46 inch/15.65 lbs (600 x 66.8 x 443.5mm/7.1 kg)  23.62 x 7.28 x 18.43 inch/19.4 lbs (600 x 185 x 468mm/8.8 kg)
Environmental Considerations	Operating Temperature Operating Humidity Storage Temperature Storage Humidity	50 °F to 104 °F (10 °C to 40 °C)  10% to 80%  -13 °F to 113 °F (-25 °C to 45 °C)  5% to 95%
Audio Characteristics	Audio Input 1 Audio Input 2 Headphone out Frequency Response Audio out	RCA Jack Red(R) White(L), 0.5Vrms (-9dB) 3.5 $\emptyset$ Stereo Jack, 0.5Vrms (-9dB) Max. 10mW Output (3.5 $\emptyset$ Stereo Jack 32)  RF: 80Hz ~ 15kHz (at- 3dB) A/V: 80Hz ~ 20kHz (at - 3dB) 7W $\times$ 2 (Option : Active Woofer 500mV RMS at 20 - 150Hz)

## Pin Assignments

### Pin DVI Connection

Pin	1	2	3	4	5	6	7	8	9	10	11	12	13	14	15
Separate H/V	Rx 2-	Rx 2+	GND	No Connection	No Connection	DDC Clock (SCL)	DDC Data (SDA)	Analog Vertical Sync	Rx 1-	Rx 1+	GND	No Connection	No Connection	DDC Input Power (+5V)	Self Laster
Pin	16	17	18	19	20	21	22	23	24	25(C3)	26(C5)	27(C4)	28(C2)	29(C5)	30(C1)
Separate H/V	Output Signal Connection	Rx 0-	Rx 0+	GND	No Connection	No Connection	GND	Rx C-	Rx C+	Analog (Blue)	Analog GND	Analog Horizontal Sync	Analog (Green)	Analog GND	Analog (Red)

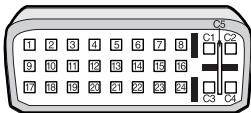

**THIS APPLIANCE IS DISTRIBUTED BY:**



BN68-00349G-00